

TSPPT300 TRANSFORMER



INSTALLATION GUIDE

ABBA LIGHTING USA

TSPPT300 TRANSFORMER

FINISH:
**STAINLESS
STEEL**

INCLUDED:
**PHOTOCELL,
36" CORD,
& MANUAL
TIMER**

**WATERPROOF
RATING:**

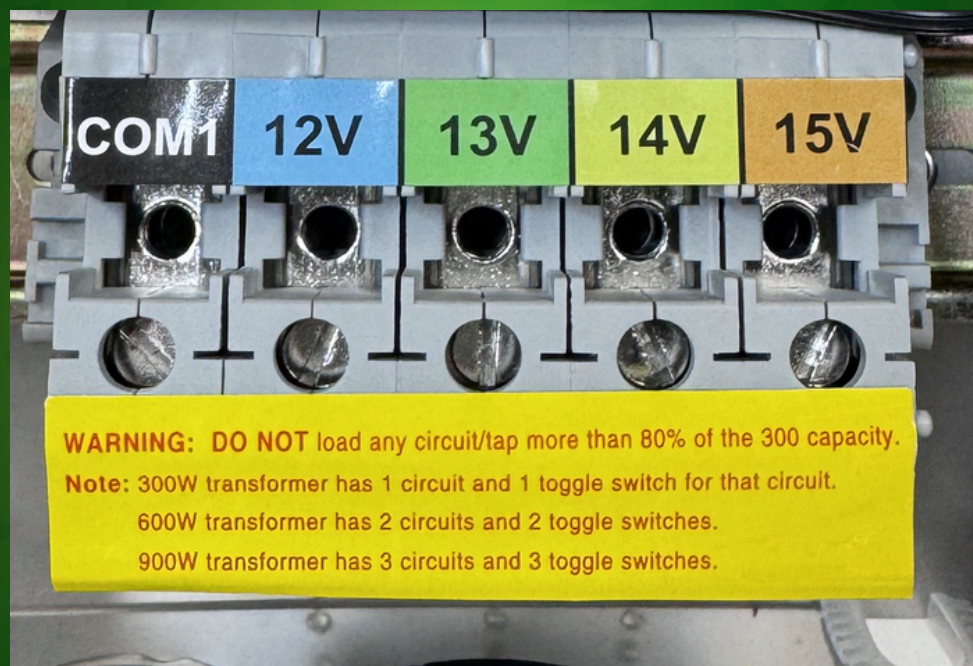

**150W AC MULTI-TAP
OUTPUT (12V, 13V, 14V, 15V)**



ABBA LIGHTING USA

Thank you for choosing our high-quality product. To ensure the best possible experience, please take a moment to carefully read and follow all instructions before assembly, installation, and use. Doing so will not only guarantee proper function and safety but also help you maximize the full potential of this exceptional product. We truly appreciate your business and are honored to be your trusted provider of top-notch products!



YOUTUBE VIDEO
INSTALLATION GUIDE



WEBSITE



CATALOG



(800) 360-2960



ABBALightingUSA@gmail.com



7701 Alabama Ave, Canoga Park, CA 91304

WARNING

TO REDUCE THE RISK OF FIRE OR INJURY TO PERSONS:

- ✓ For safety reasons, we recommend that only a qualified professional install this electrical product.
- ✓ Before attempting to install this unit, ensure all power connections are off for your own safety.
- ✓ Fixture(s) must be installed in accordance with all local codes and ordinances.
- ✓ Do not instal within 10 feet of a pool, spa or fountain
- ✓ DO NOT DISASSEMBLE
- ✓ To ensure proper functionality and safety, it is important to refrain from connecting two or more transformers in parallel. It is advised to maintain individual electrical circuits for each transformer rather than attempting to combine their outputs. By adhering to this guideline, you can prevent potential complications and optimize the performance of each transformer.
- ✓ For optimal performance and safety, it is recommended not to utilize this device in conjunction with a dimmer switch. Avoid connecting the device to any dimming mechanism as it may lead to undesirable consequences or malfunctioning. It is advisable to operate the device without the use of a dimmer to ensure its intended functionality and prevent any potential risks.
- ✓ To ensure the highest level of safety, it is recommended to directly plug the transformer into a Ground Fault Circuit Interrupter (GFCI) outlet. By utilizing a GFCI outlet, you enhance protection against electrical shocks and minimize the risk of electrical hazards.

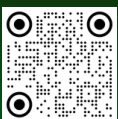

YOUTUBE VIDEO
INSTALLATION GUIDE



WEBSITE



CATALOG



(800) 360-2960



ABBALightingUSA@gmail.com



7701 Alabama Ave, Canoga Park, CA 91304

WARNING

TO REDUCE THE RISK OF FIRE OR INJURY TO PERSONS:



To maintain optimal performance and safety, it is strongly advised against using an extension cord with this device. It is recommended to directly connect the device to a properly grounded power outlet. Using an extension cord may introduce electrical inefficiencies, increase the risk of overheating, or compromise the device's functionality. It is best to avoid extension cords and ensure a direct and secure power connection for the device.



It is important to note that the maximum rated output of this transformer is 300 watts. For optimal performance and long-term reliability, the total connected load should not exceed this limit, and it is strongly recommended that the transformer be operated at no more than 80% of its rated capacity.

Maintaining the load within this range helps minimize heat buildup, improves operating efficiency, and significantly extends the service life of the transformer. Exceeding the rated capacity – or consistently operating near the maximum limit – may result in overheating, reduced performance, and potential damage to the unit. Careful calculation and management of the total wattage of connected fixtures is therefore essential to ensure safe operation and long-term system stability.

WARRANTY

- We stand behind the quality of our product and offer a 3 year warranty. Kindly ensure that you keep the proof of purchase as it will be required for any warranty claims.
- Warranty will be void if there is any damage due to improper usage or modification to the fixture.
- Failure to comply with the instruction in this manual may increase the risk of damage or injury and will void warranty.



YOUTUBE VIDEO
INSTALLATION GUIDE



WEBSITE

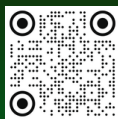

CATALOG



(800) 360-2960



ABBALightingUSA@gmail.com



7701 Alabama Ave, Canoga Park, CA 91304

CAUTION:

FIXTURE(S) MUST BE INSTALLED IN ACCORDANCE WITH ALL LOCAL CODES AND ORDINANCES.

DO NOT INSTALL WITHIN 10 FEET OF A POOL, SPA OR FOUNTAIN

TSRPT300 300W Stainless Steel Manual Transformer — Robust Power for Outdoor Low-Voltage Lighting

The TSRPT300 300W Stainless Steel Manual Transformer from Abba Lighting USA is a premium power supply solution engineered to drive low-voltage landscape lighting systems with reliability, durability, and ease of control. Constructed with a corrosion-resistant stainless steel housing, this transformer delivers consistent performance in demanding outdoor environments while offering manual control for customized operation.

With a 300-watt capacity, the TSRPT300 provides dependable power to a broad range of low-voltage lighting fixtures — including pathway lights, spotlights, deck lights, and accent illumination. Its manual control interface allows installers and homeowners to easily manage lighting schedules and adjust operation without reliance on digital programming.

Designed for professional installations and long-term outdoor use, the TSRPT300 combines strength, flexibility, and intuitive operation to support both residential and commercial landscape lighting applications.

Heavy-Duty Stainless Steel Construction

The rugged stainless steel enclosure resists rust and environmental wear, making this transformer ideal for exterior installations with maximum durability.



YOUTUBE VIDEO
INSTALLATION GUIDE



WEBSITE

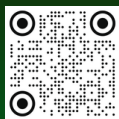

CATALOG



(800) 360-2960



ABBALightingUSA@gmail.com



7701 Alabama Ave, Canoga Park, CA 91304

CAUTION:

FIXTURE(S) MUST BE INSTALLED IN ACCORDANCE WITH ALL LOCAL CODES AND ORDINANCES.

DO NOT INSTALL WITHIN 10 FEET OF A POOL, SPA OR FOUNTAIN

300W Power Output

Provides ample capacity to power clusters of low-voltage lighting fixtures while maintaining stable voltage and consistent performance.

Manual Control Interface

Allows users to switch lighting systems ON or OFF without complex programming — perfect for hands-on adjustment and straightforward operation.

Designed for Outdoor Use

Built to withstand moisture, temperature changes, UV exposure, and other outdoor conditions for reliable long-term service.

Flexible Lighting Support

Suitable for a wide range of low-voltage outdoor lighting applications, including pathways, gardens, decks, architectural accents, and commercial landscapes.

Easy Integration

Works seamlessly within standard low-voltage landscape lighting systems for simple setup and compatibility with existing wiring and fixtures.



YOUTUBE VIDEO
INSTALLATION GUIDE



WEBSITE



CATALOG



(800) 360-2960



ABBALightingUSA@gmail.com



7701 Alabama Ave, Canoga Park, CA 91304

CAUTION:

FIXTURE(S) MUST BE INSTALLED IN ACCORDANCE WITH ALL LOCAL CODES AND ORDINANCES.

DO NOT INSTALL WITHIN 10 FEET OF A POOL, SPA OR FOUNTAIN

This transformer has been engineered with the highest standards of safety and reliability, making it fully suitable for both indoor and outdoor installations. Its weatherproof construction provides superior protection against environmental exposure, ensuring consistent performance and long-term durability even under demanding weather conditions. You may therefore deploy this transformer with complete confidence in a wide range of operating environments without compromising safety or functionality.

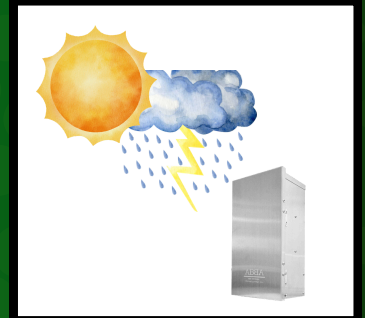

For optimal operation and ease of use, the transformer must be installed at a height and location where the control panel remains clearly visible and readily accessible. Proper placement allows for convenient monitoring, adjustment, and routine maintenance. When selecting the mounting location, carefully evaluate factors such as operator line of sight, reachability, and ergonomic comfort. Installing the unit in an accessible position significantly enhances usability and supports efficient system management.

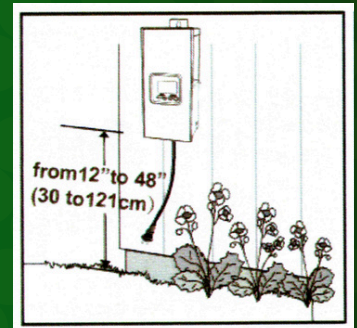

Additionally, do not install the transformer in any position that interferes with the dusk-to-dawn sensor. The sensor must maintain an unobstructed line of sight to accurately detect ambient light levels. Any obstruction may impair the sensor's ability to function correctly and compromise the automatic lighting control feature. Ensuring the sensor remains fully exposed guarantees precise operation of the dusk-to-dawn mode, thereby maximizing the performance, efficiency, and reliability of the overall lighting system.

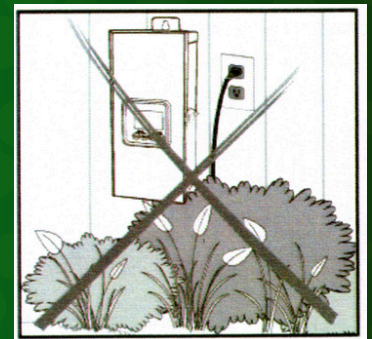

YOUTUBE VIDEO
INSTALLATION GUIDE



WEBSITE



CATALOG



(800) 360-2960



ABBALightingUSA@gmail.com



7701 Alabama Ave, Canoga Park, CA 91304





CAUTION:

FIXTURE(S) MUST BE INSTALLED IN ACCORDANCE WITH ALL LOCAL CODES AND ORDINANCES.

DO NOT INSTALL WITHIN 10 FEET OF A POOL, SPA OR FOUNTAIN

MOUNTING INSTALLATION

To mount the transformer on a wall near an electrical outlet, carefully follow these step-by-step instructions:

-  Select an appropriate mounting location on the wall in close proximity to the electrical outlet where the transformer will be installed. The chosen location must provide unobstructed access to the outlet and be structurally capable of supporting the weight and dimensions of the transformer. Proper site selection ensures safe installation, reliable operation, and long-term stability of the unit.
-  Hold the transformer firmly against the wall at the selected mounting height. Carefully align the unit with the nearby electrical outlet and all required connection points to ensure proper cable routing and secure installation.
-  Using a pencil or suitable marking tool, clearly mark the wall at each location corresponding to the transformer's mounting holes. These reference points will serve as precise guides for drilling and will ensure accurate alignment and secure fastening of the unit.
-  Select mounting screws that are fully compatible with both the wall material and the transformer's mounting holes. When installing on drywall, plaster, or other non-structural surfaces, the use of appropriate wall anchors is strongly recommended to ensure secure attachment. If there is any uncertainty regarding proper hardware selection, consult a qualified hardware supplier or professional installer to obtain mounting components suitable for the specific installation conditions.



YOUTUBE VIDEO
INSTALLATION GUIDE



WEBSITE



CATALOG



(800) 360-2960



ABBALightingUSA@gmail.com



7701 Alabama Ave, Canoga Park, CA 91304

CAUTION:

FIXTURE(S) MUST BE INSTALLED IN ACCORDANCE WITH ALL LOCAL CODES AND ORDINANCES.

DO NOT INSTALL WITHIN 10 FEET OF A POOL, SPA OR FOUNTAIN

MOUNTING INSTALLATION



Using an appropriate screwdriver or power drill, carefully drive the mounting screws through the transformer's mounting holes and into the pre-marked locations on the wall. Ensure that each screw is inserted straight and tightened firmly to provide a stable and secure attachment of the unit.



After all mounting screws have been fully tightened, carefully test the stability of the transformer by applying light pressure or a gentle pull. Confirm that the unit is firmly secured and does not exhibit any movement or looseness.

To mitigate voltage drops effectively, it is advisable to employ the 15V block. This particular device ensures a stable and consistent voltage supply, minimizing any potential reduction in voltage levels throughout the electrical system. By utilizing the 15V block, you can maintain a reliable power flow and prevent any undesirable fluctuations that could impact the performance or functionality of connected devices.

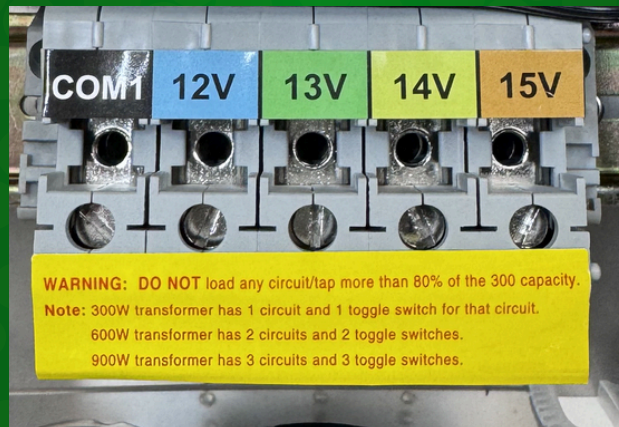

YOUTUBE VIDEO
INSTALLATION GUIDE



WEBSITE



CATALOG



(800) 360-2960



ABBALightingUSA@gmail.com



7701 Alabama Ave, Canoga Park, CA 91304

CAUTION:

FIXTURE(S) MUST BE INSTALLED IN ACCORDANCE WITH ALL LOCAL CODES AND ORDINANCES.

DO NOT INSTALL WITHIN 10 FEET OF A POOL, SPA OR FOUNTAIN

Wiring Preparation & Electrical Connection

To prepare the landscape wiring for connection, proceed as follows:

1. Using an appropriate wire-stripping tool, remove approximately ½ inch (13 mm) of insulation from the end of each conductor.
2. Tightly twist the exposed copper strands of each wire to prevent fraying and ensure a solid electrical contact.

To connect the wires to the transformer:

1. Pull up the button clamp plate. Fully insert each prepared wire beneath the appropriate terminal plate.
2. Pull down the button clamp securely to firmly clamp the conductors in place.

After completing the wiring connections, perform the following verification steps to ensure proper installation:

1. Visually inspect all terminal blocks to confirm that each wire is fully seated and securely clamped, with no loose strands or exposed conductors.
2. Gently pull on each wire to confirm that it is firmly held and cannot be removed without loosening the terminal screw.

Following these procedures ensures reliable electrical connections, minimizes the risk of disconnection or electrical malfunction, and promotes safe, long-term operation. Once verification is complete, ensure the transformer casing is properly closed to protect internal components from environmental exposure and physical damage.



YOUTUBE VIDEO
INSTALLATION GUIDE



WEBSITE



CATALOG



(800) 360-2960



ABBALightingUSA@gmail.com



7701 Alabama Ave, Canoga Park, CA 91304

CAUTION:

FIXTURE(S) MUST BE INSTALLED IN ACCORDANCE WITH ALL LOCAL CODES AND ORDINANCES.

DO NOT INSTALL WITHIN 10 FEET OF A POOL, SPA OR FOUNTAIN

Photocell-to-Transformer Connection Guide

Carefully remove the designated knockout opening on the side of the transformer.

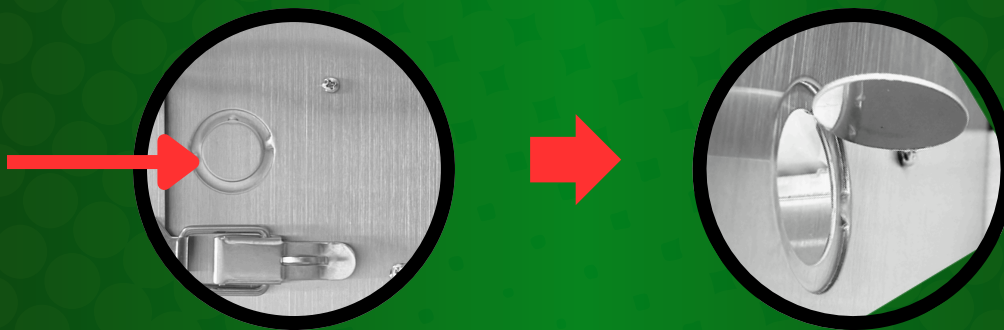

Insert the photocell into the exposed knockout opening on the transformer housing. Secure the photocell in place using the provided mounting screw, ensuring that it is firmly fastened and properly seated.

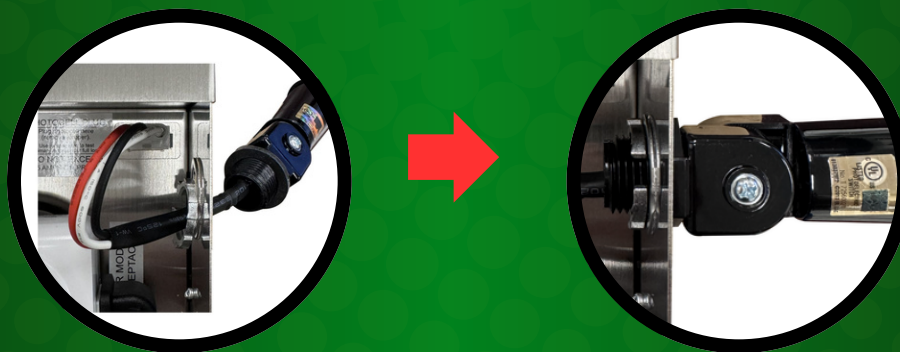

YOUTUBE VIDEO
INSTALLATION GUIDE

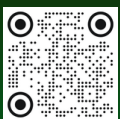

WEBSITE



CATALOG



(800) 360-2960



ABBALightingUSA@gmail.com



7701 Alabama Ave, Canoga Park, CA 91304

CAUTION:

FIXTURE(S) MUST BE INSTALLED IN ACCORDANCE WITH ALL LOCAL CODES AND ORDINANCES.

DO NOT INSTALL WITHIN 10 FEET OF A POOL, SPA OR FOUNTAIN

Remove the protective tab from the connector port. Then, insert the photocell wire connector fully into the designated connection slot on the transformer until it is securely seated.

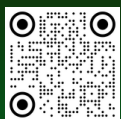

YOUTUBE VIDEO
INSTALLATION GUIDE



WEBSITE



CATALOG



(800) 360-2960



ABBALightingUSA@gmail.com



7701 Alabama Ave, Canoga Park, CA 91304

FIXTURE(S) MUST BE INSTALLED IN ACCORDANCE WITH ALL LOCAL CODES AND ORDINANCES.

DO NOT INSTALL WITHIN 10 FEET OF A POOL, SPA OR FOUNTAIN

Operate the system using the photocell.

The photocell functions by detecting ambient sunlight. When sufficient daylight is present, the photocell will automatically turn the system OFF. When sunlight is no longer detected (at dusk or during darkness), the photocell will automatically turn the system ON.

For proper operation, ensure that the photocell is not obstructed by any objects, debris, or nearby surfaces that may block light from reaching the sensor.

The photocell must be installed outdoors in an area with direct exposure to natural daylight.

Do not install the transformer indoors when using the photocell feature, as indoor placement will prevent the sensor from detecting sunlight and will result in improper operation.

Correct placement and clear exposure to daylight are essential for reliable photocell performance.

TO ENABLE AUTOMATIC OPERATION USING THE PHOTOCELL FUNCTION, ENSURE THAT ALL TIMER CONTROL BUTTONS ARE POSITIONED IN THE DOWN SETTING AND THAT THE SELECTOR SWITCH ON THE TM02 IS SET TO TIMER MODE.

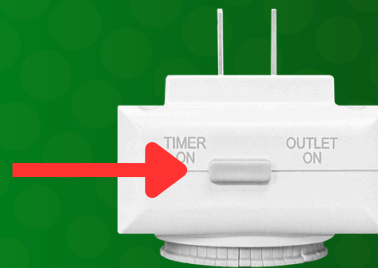
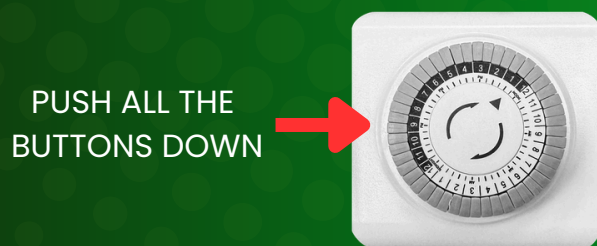

YOUTUBE VIDEO
INSTALLATION GUIDE



WEBSITE

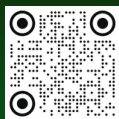

CATALOG



(800) 360-2960



ABBALightingUSA@gmail.com



7701 Alabama Ave, Canoga Park, CA 91304

CAUTION:

FIXTURE(S) MUST BE INSTALLED IN ACCORDANCE WITH ALL LOCAL CODES AND ORDINANCES.

DO NOT INSTALL WITHIN 10 FEET OF A POOL, SPA OR FOUNTAIN

Operate the system using the Timer.

The TM02 Mechanical Timer allows automatic control of connected electrical devices by scheduling ON and OFF periods throughout the day. The timer operates using a rotating dial with programmable segments, providing reliable time-based control without digital programming.

The timer uses mechanical buttons (segments) around the dial to define when the connected device will operate.

When a button is pushed down, the connected device will remain ON during that 30-minute time interval.

When the button is up, the connected device will remain OFF during that 30-minute interval.

Each individual button represents a 30-minute increments, allowing precise customization of the operating schedule.

Setting the Current Time

Accurate time alignment is essential for correct program operation.

1. Rotate the timer dial clockwise only.
2. Continue turning the dial until the arrow indicator points exactly to the current time on the clock face.

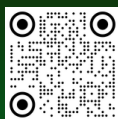

YOUTUBE VIDEO
INSTALLATION GUIDE



WEBSITE



CATALOG



(800) 360-2960



ABBALightingUSA@gmail.com



7701 Alabama Ave, Canoga Park, CA 91304

CAUTION:

FIXTURE(S) MUST BE INSTALLED IN ACCORDANCE WITH ALL LOCAL CODES AND ORDINANCES.

DO NOT INSTALL WITHIN 10 FEET OF A POOL, SPA OR FOUNTAIN

The clock face is divided into two sections. Confirm the correct AM/PM position by referencing the light and dark areas of the dial

White area — AM hours

Dark area — PM hours

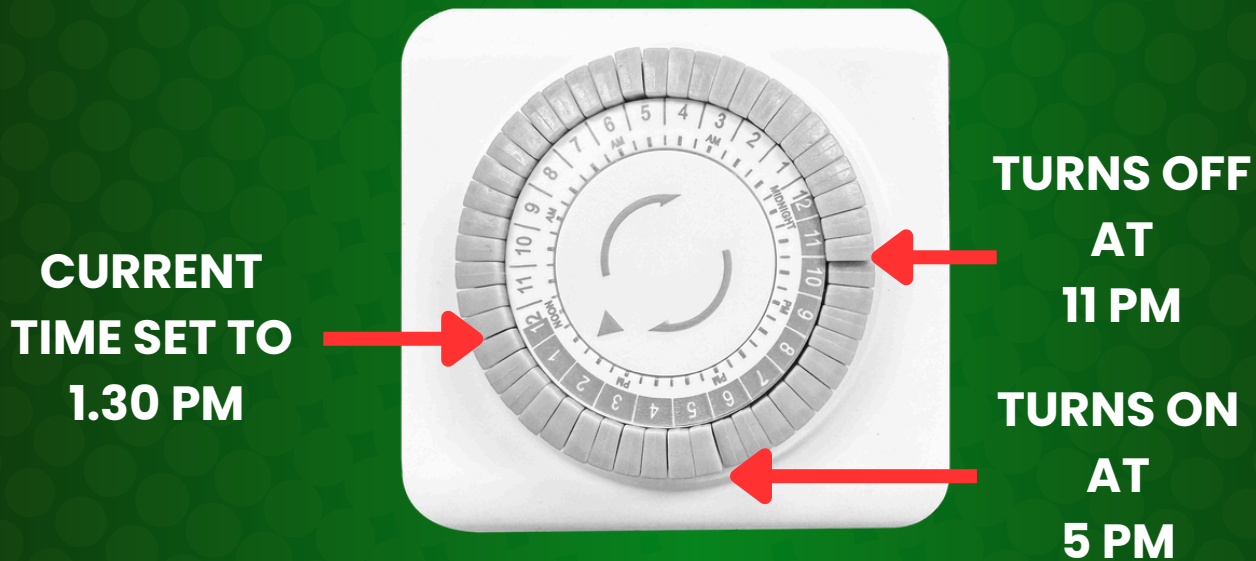

In the illustrated example, the current time is set to 1:30 PM, as indicated by the alignment of the arrow on the dial. Each segment on the timer dial represents a 30-minute interval.

The timer buttons are pressed DOWN from 5:00 PM to 11:00 PM, which programs the transformer to turn ON at 5:00 PM and turn OFF at 11:00 PM. Any buttons positioned UP indicate periods when the transformer is scheduled to remain OFF.

This configuration allows precise control of the operating schedule based on half-hour increments.

Once set, the timer will follow the programmed schedule according to real time.

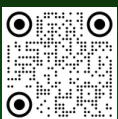

YOUTUBE VIDEO
INSTALLATION GUIDE



WEBSITE



CATALOG



(800) 360-2960



ABBALightingUSA@gmail.com



7701 Alabama Ave, Canoga Park, CA 91304

CAUTION:

FIXTURE(S) MUST BE INSTALLED IN ACCORDANCE WITH ALL LOCAL CODES AND ORDINANCES.

DO NOT INSTALL WITHIN 10 FEET OF A POOL, SPA OR FOUNTAIN

3. Manual Switch Operation

The timer includes a manual control switch with two operating modes:

TIMER ON

When the switch is set to ON, the timer follows the programmed schedule you configured using the buttons on the dial.

OUTLET ON (Constant ON / Bypass Mode)

When the switch is set to **OUTLET ON** the timer bypasses the schedule and supplies continuous power, turning the connected device ON immediately.

Use this mode when you need temporary manual operation without changing the programmed schedule.

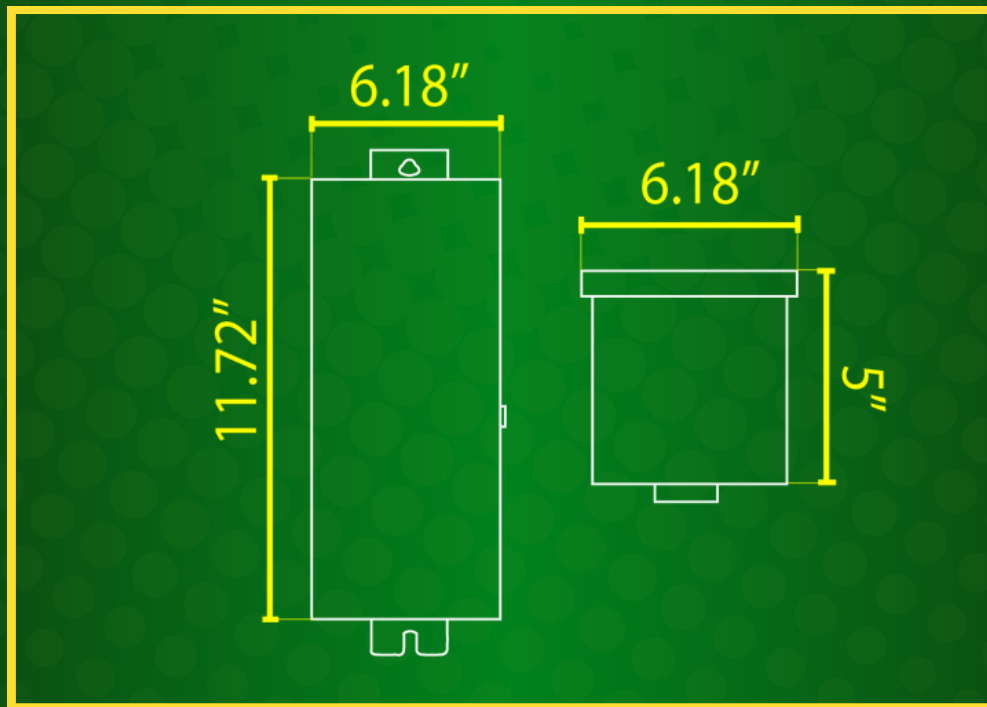

YOUTUBE VIDEO
INSTALLATION GUIDE



WEBSITE



CATALOG



(800) 360-2960



ABBALightingUSA@gmail.com



7701 Alabama Ave, Canoga Park, CA 91304

INSTALLATION GUIDE FOR TSRPT300

MAINTENANCE TIPS

- **Regular Inspection:** Periodically check the bracket and fixture to ensure they are still securely mounted and functioning correctly.

SAFETY PRECAUTIONS

- Always wear appropriate safety gear, such as gloves and safety glasses, during installation.
- Ensure the mounting surface is capable of supporting the weight of both the bracket and the lighting fixture.

ADDITIONAL RESOURCES

FOR A DETAILED VIDEO TUTORIAL ON HOW TO INSTALL, VISIT OUR YOUTUBE CHANNEL AND SEARCH FOR "TSRPT300"

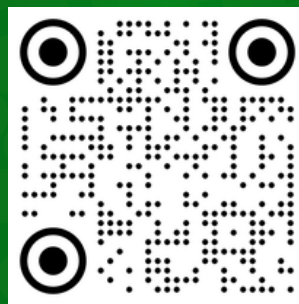

Please visit our website for more of our products.

www.ABBALightingUSA.com



YOUTUBE VIDEO
INSTALLATION GUIDE



WEBSITE

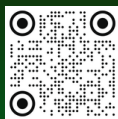

CATALOG



(800) 360-2960



ABBALightingUSA@gmail.com



7701 Alabama Ave, Canoga Park, CA 91304

TSRPT300

TRANSFORMERS



ABBA

LIGHTING USA

12V Landscape Light Specialist

ABBA LIGHTING USA