

STAIR STEP LIGHT

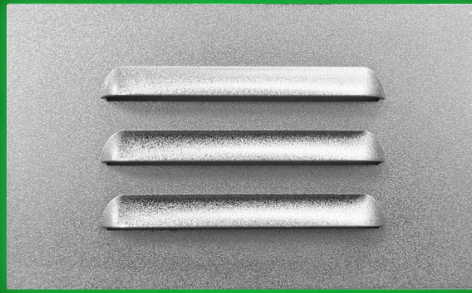

INSTALLATION GUIDE

ABBA LIGHTING USA

STAIR STEP LIGHT

FEATURE:

**SURFACE
MOUNT**

MATERIAL:

**HEAVY
DUTY
CAST
ALUMINUM**

WATERPROOF
RATING:



BLACK



WHITE



BROWN



SILVER



3.5W AC/DC 12V

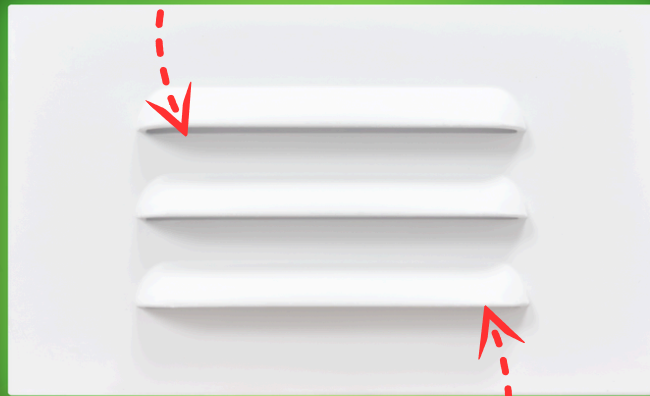

315 LUMENS

TEMPERATURE:

**3000K
WARM
WHITE**

ABBA LIGHTING USA

Thank you for choosing our high-quality product. To ensure the best possible experience, please take a moment to carefully read and follow all instructions before assembly, installation, and use. Doing so will not only guarantee proper function and safety but also help you maximize the full potential of this exceptional product. We truly appreciate your business and are honored to be your trusted provider of top-notch products!



YOUTUBE VIDEO
INSTALLATION GUIDE



WEBSITE



CATALOG



(800) 360-2960



ABBALightingUSA@gmail.com



7701 Alabama Ave, Canoga Park, CA 91304

WARNING

TO REDUCE THE RISK OF FIRE OR INJURY TO PERSONS:

- ✓ Please exercise caution when using the lamp, as it tends to HEAT up rapidly. We recommend taking necessary safety measures to ensure optimal usage.
- ✓ For your safety, please refrain from touching the HOT lens, guard, or enclosure. We recommend waiting for the product to cool down before handling it.
- ✓ To prevent any fire hazards, please ensure that the lamp is kept away from materials that may easily catch fire. We appreciate your cooperation in maintaining a safe and secure environment.
- ✓ For safety reasons, we recommend that only a qualified professional install this electrical product.
- ✓ Before attempting to install this unit, ensure all power connections are off for your own safety.

WARRANTY

- We stand behind the quality of our product and offer a 2 year warranty. Kindly ensure that you keep the proof of purchase as it will be required for any warranty claims.
- Warranty will be void if there is any damage due to improper usage or modification to the fixture.
- Failure to comply with the instruction in this manual may increase the risk of damage or injury and will void warranty.



YOUTUBE VIDEO
INSTALLATION GUIDE



WEBSITE



CATALOG



(800) 360-2960



ABBALightingUSA@gmail.com



7701 Alabama Ave, Canoga Park, CA 91304

CAUTION:

FIXTURE(S) MUST BE INSTALLED IN ACCORDANCE WITH ALL LOCAL CODES AND ORDINANCES.

DO NOT INSTALL WITHIN 10 FEET OF A POOL, SPA OR FOUNTAIN

STA11 Integrated Aluminum Step Light – Sleek and Reliable Outdoor Illumination

The STA11 Integrated Aluminum Step Light from Abba Lighting USA is a refined, low-profile lighting fixture designed for steps, deck edges, patios, walkways, and other outdoor surfaces where subtle illumination enhances both safety and design. With a robust aluminum body and an integrated LED light source, this step light provides dependable performance while maintaining a clean, architectural appearance.

The STA11 is engineered for flush installation, allowing the fixture to sit nearly level with the surface for an unobtrusive look that complements a variety of landscape and hardscape styles. Its integrated LED delivers smooth, consistent light output without the need for replacement bulbs, lowering maintenance and ensuring long-lasting illumination.

Whether you're enhancing safety on stair risers, adding visual definition to deck perimeters, or creating gentle accent light along outdoor pathways, the STA11 integrates reliable lighting performance with a discreet, elegant presence.

Heavy-Duty Cast Aluminum Body

Built for durability and corrosion resistance in outdoor environments.



YOUTUBE VIDEO
INSTALLATION GUIDE



WEBSITE

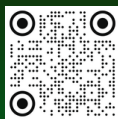

CATALOG



(800) 360-2960



ABBALightingUSA@gmail.com



7701 Alabama Ave, Canoga Park, CA 91304

CAUTION:

FIXTURE(S) MUST BE INSTALLED IN ACCORDANCE WITH ALL LOCAL CODES AND ORDINANCES.

DO NOT INSTALL WITHIN 10 FEET OF A POOL, SPA OR FOUNTAIN

Multiple Finish Options

Available in Black, Brown, White, or Stainless Steel to complement a wide range of design styles.

Warm White 3000K Output

Produces an inviting, natural glow ideal for steps, decks, and walkways.

Aluminum Construction

Durable, corrosion-resistant aluminum housing offers long-lasting performance in outdoor and indoor applications.

Fits Standard Bell Box

Designed to mount on a standard bell box (sold separately) for easier installation and compatibility.

Outdoor Rated

Built to withstand moisture and environmental exposure, making it suitable for exterior installation near walkways, patios, and decks.

Installation-Friendly

Designed for straightforward installation with trim-less mounting, and compatible with standard low-voltage lighting systems.



YOUTUBE VIDEO
INSTALLATION GUIDE



WEBSITE



CATALOG



(800) 360-2960



ABBALightingUSA@gmail.com



7701 Alabama Ave, Canoga Park, CA 91304

CAUTION:

FIXTURE(S) MUST BE INSTALLED IN ACCORDANCE WITH ALL LOCAL CODES AND ORDINANCES.

DO NOT INSTALL WITHIN 10 FEET OF A POOL, SPA OR FOUNTAIN

3.5W Low-Voltage Operation

Runs on 12V AC/DC, ensuring safe and efficient integration with landscape lighting systems.

Sleek Recessed Mount Design

Flush installation provides a modern, unobtrusive appearance.

Technical Specifications

Model STA11

Body / Material Heavy-Duty Cast Aluminum

Finish Options Black, Brown, White, Stainless Steel

Power Consumption 3.5W

Operating Voltage 12V AC/DC

Color Temperature 3000K (Warm White)

Luminous Output 315 Lumens

Dimmable No

Waterproof Rating IP65

Mounting Style Sleek recessed mount

Compatibility Fits standard bell box (sold separately)

Master Carton 48 pcs

Application Steps, decks, walls, walkways, patios



YOUTUBE VIDEO
INSTALLATION GUIDE



WEBSITE



CATALOG



(800) 360-2960



ABBALightingUSA@gmail.com



7701 Alabama Ave, Canoga Park, CA 91304

CAUTION:

FIXTURE(S) MUST BE INSTALLED IN ACCORDANCE WITH ALL LOCAL CODES AND ORDINANCES.

DO NOT INSTALL WITHIN 10 FEET OF A POOL, SPA OR FOUNTAIN

Ideal Applications

- Stair risers along outdoor decks or patios
- Vertical accents on walls and architectural surfaces
- Pathway and step safety illumination
- Interior step lighting for transitional spaces
- Commercial exterior accent lighting



YOUTUBE VIDEO
INSTALLATION GUIDE



WEBSITE



CATALOG



(800) 360-2960



ABBALightingUSA@gmail.com



7701 Alabama Ave, Canoga Park, CA 91304

CAUTION:

INSTALLATION GUIDE FOR STAFF

STEP-BY-STEP INSTALLATION INSTRUCTIONS

To ensure optimal performance and maximum safety, use this fixture **ONLY** with a low-voltage landscape transformer.

The transformer reduces standard household voltage from 120V to 12V, making it safe and suitable for outdoor applications.

1. Power Safety

Before installation, confirm that electrical power is completely turned OFF.

2. Position the Mounting Plate

Hold the metal mounting plate against the wall or mounting surface at the desired height and orientation.

Use a level to ensure proper horizontal or vertical alignment.

3. Mark Mounting Points

Using a pencil or marker, mark the screw hole locations through the holes in the metal plate.

4. Drill Pilot Holes

Select a drill bit slightly smaller than the mounting screws.

Drill pilot holes at the marked locations, ensuring the depth matches the length of the screws.

5. Prepare the Opening

Create an opening at the desired fixture location:

- Concrete Surface: Use a suitable outlet/junction box (not included).
- Deck Installation: Punch or cut an opening using appropriate tools or install an outlet/junction box.

Use a drill bit or hole saw that matches the size of the provided metal plate to produce a clean, accurate opening.



YOUTUBE VIDEO
INSTALLATION GUIDE



WEBSITE



CATALOG



(800) 360-2960



ABBALightingUSA@gmail.com



7701 Alabama Ave, Canoga Park, CA 91304

CAUTION:

INSTALLATION GUIDE FOR STAFF

STEP-BY-STEP INSTALLATION INSTRUCTIONS

6. Concrete Conduit Preparation (If Applicable)

For concrete installations, install conduit raceways inside the formwork before pouring the concrete using 1-inch dowels and PVC pipe.

After the concrete cures, remove the dowels and finish the riser surface as needed.

7. Secure the Mounting Plate

Align the metal plate with the pilot holes and insert the screws.

Tighten evenly using a screwdriver until the plate is secure. Do not overtighten. Verify that the plate is firm, level, and free of movement.

8. Wiring Connections

Strip approximately 3/4 inch (1.9 cm) of insulation from each wire.

Align the bare wire ends and insert them fully into the wire nut.

Twist the wire nut clockwise until tight and secure.

Gently tug each wire to confirm proper connection.

For additional protection, wrap electrical tape around the connection.

We recommend using WN12 waterproof wire nuts (sold separately).

9. Install Fixture

Align the clips on the fixture with the corresponding slots on the mounting plate.

Press gently until the fixture locks into place with a snug fit.

10. Restore Power & Test

Turn the power back ON at the breaker.

Test the fixture to confirm proper operation and adjust lighting direction if needed.



YOUTUBE VIDEO
INSTALLATION GUIDE



WEBSITE



CATALOG



(800) 360-2960



ABBALightingUSA@gmail.com



7701 Alabama Ave, Canoga Park, CA 91304

INSTALLATION GUIDE FOR STAFF



WN12



WN12

MAIN LINE

Attach the wires from the fixture(s) to the main cable, For best results, we recommend using WN12 waterproof wire nuts (which are sold separately)

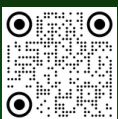
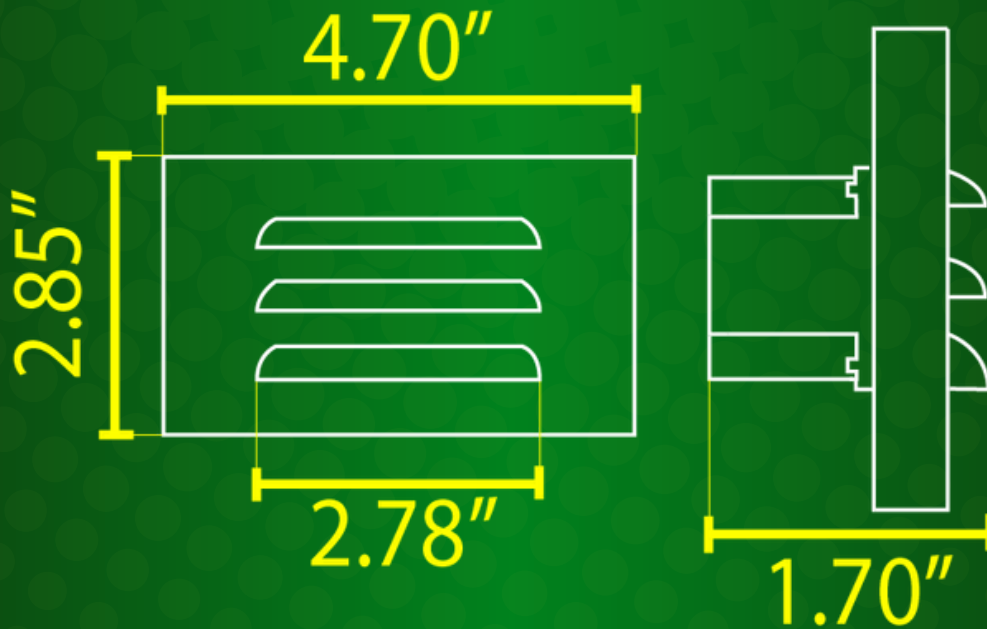

YOUTUBE VIDEO
INSTALLATION GUIDE



WEBSITE



CATALOG



(800) 360-2960



ABBALightingUSA@gmail.com



7701 Alabama Ave, Canoga Park, CA 91304

INSTALLATION GUIDE FOR STA11

MAINTENANCE TIPS

- **Regular Inspection:** Periodically check the bracket and fixture to ensure they are still securely mounted and functioning correctly.

SAFETY PRECAUTIONS

- Always wear appropriate safety gear, such as gloves and safety glasses, during installation.
- Ensure the mounting surface is capable of supporting the weight of both the bracket and the lighting fixture.

ADDITIONAL RESOURCES

For a detailed video tutorial on how to install, visit our YouTube channel and search for "STA11"

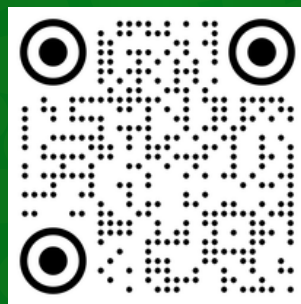

Please visit our website for more of our products.

www.ABBALightingUSA.com

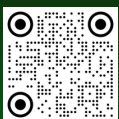

YOUTUBE VIDEO
INSTALLATION GUIDE



WEBSITE



CATALOG



(800) 360-2960



ABBALightingUSA@gmail.com



7701 Alabama Ave, Canoga Park, CA 91304

STATI

STEP LIGHT



WHITE



BROWN



BLACK

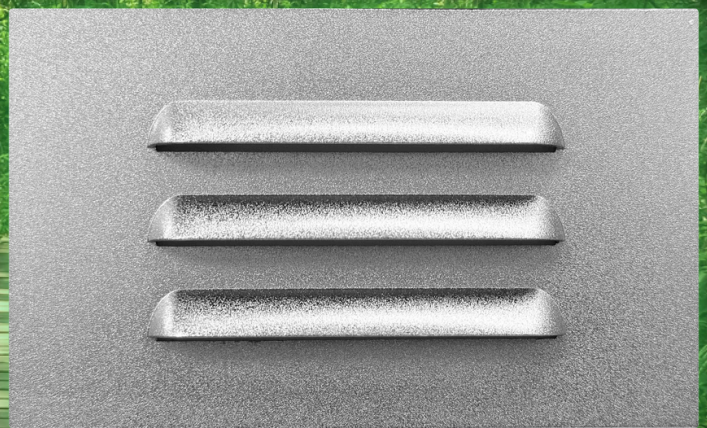

SILVER