

UUBO

UNDERWATER LIGHT



INSTALLATION GUIDE

ABBA LIGHTING USA

UBO UNDERWATER LIGHT



**HEAVY DUTY
CAST
BRASS**

FINISH



Thank you for choosing our high-quality product. To ensure the best possible experience, please take a moment to carefully read and follow all instructions before assembly, installation, and use. Doing so will not only guarantee proper function and safety but also help you maximize the full potential of this exceptional product. We truly appreciate your business and are honored to be your trusted provider of top-notch products!

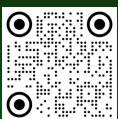

YOUTUBE VIDEO
INSTALLATION GUIDE



WEBSITE



CATALOG



(800) 360-2960



ABBALightingUSA@gmail.com



7701 Alabama Ave, Canoga Park, CA 91304

WARNING

TO REDUCE THE RISK OF FIRE OR INJURY TO PERSONS:

- ✔ Please exercise caution when using the lamp, as it tends to HEAT up rapidly. We recommend taking necessary safety measures to ensure optimal usage.
- ✔ For your safety, please refrain from touching the HOT lens, guard, or enclosure. We recommend waiting for the product to cool down before handling it.
- ✔ To prevent any fire hazards, please ensure that the lamp is kept away from materials that may easily catch fire. We appreciate your cooperation in maintaining a safe and secure environment.
- ✔ For safety reasons, we recommend that only a qualified professional install this electrical product.
- ✔ Before attempting to install this unit, ensure all power connections are off for your own safety.

WARRANTY

- We stand behind the quality of our product and offer a 5 Year warranty. Kindly ensure that you keep the proof of purchase as it will be required for any warranty claims.
- Warranty will be void if there is any damage due to improper usage or modification to the fixture.
- Failure to comply with the instruction in this manual may increase the risk of damage or injury and will void warranty.



YOUTUBE VIDEO
INSTALLATION GUIDE



WEBSITE



CATALOG



(800) 360-2960



ABBALightingUSA@gmail.com



7701 Alabama Ave, Canoga Park, CA 91304

CAUTION:

FIXTURE(S) MUST BE INSTALLED IN ACCORDANCE WITH ALL LOCAL CODES AND ORDINANCES.

PRODUCT OVERVIEW

The ULB01 Brass Underwater Light is a durable low-voltage fixture designed for water-feature lighting applications where strength, reliability, and a premium appearance are essential. Built with a heavy-duty cast brass body and finished in Natural Brass, this model offers a more substantial and refined alternative to ordinary underwater fixtures. Its solid brass construction gives it the durability needed for demanding outdoor environments while also providing the classic, professional look that works beautifully in decorative landscape and water installations.

Designed to operate with an MR16 LED 12V bulb sold separately, the ULB01 gives installers the freedom to choose the lamp that best fits the project's desired brightness and color tone. The product page references several compatible MR16 LED bulb options, including multiple wattages and color temperatures, making this fixture flexible enough for a range of lighting effects. Whether the goal is a warmer and more inviting glow or a cleaner, brighter accent, this housing can be adapted to suit different pond and fountain designs.

The ULB01 is built specifically for wet-location and underwater use. It carries an IP68 waterproof rating and is associated on the product page with applications such as ponds, fountains, and waterfalls. This makes it a practical solution for illuminating moving water, highlighting pond edges, or adding focused light to decorative water features. Its compact but solid form allows it to integrate well into a variety of landscape layouts without sacrificing durability or visual quality.

Another strength of this fixture is its professional-grade construction and recognized certification. Adding confidence for customers and installers who want a dependable underwater fixture from a quality-conscious product line. With its brass housing, underwater-rated design, and flexible MR16 lamp compatibility, the ULB01 is a strong choice for projects that need attractive and reliable illumination in water-feature environments.

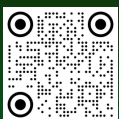

YOUTUBE VIDEO
INSTALLATION GUIDE



WEBSITE

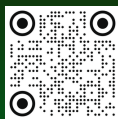

CATALOG



(800) 360-2960



ABBALightingUSA@gmail.com



7701 Alabama Ave, Canoga Park, CA 91304

CAUTION:

FIXTURE(S) MUST BE INSTALLED IN ACCORDANCE WITH ALL LOCAL CODES AND ORDINANCES.

KEY FEATURES

- Heavy-duty cast brass construction for long-lasting performance in outdoor and wet environments.
- Natural Brass finish for a rich, professional appearance.
- Designed for MR16 LED 12V lamp use. Bulb sold separately.
- Suitable for underwater and water-feature applications such as ponds, fountains, and waterfalls.
- IP68 waterproof rating for dependable protection in wet conditions.

Specification	Details
Model	ULB01 Brass Underwater Light
Body Material	Heavy Duty Cast Brass
Finish	Natural Brass
Bulb Requirement	MR16 LED, 12V, sold separately
Size	4.60" (L) x 4.40" (W) x 4.40" (H)
Waterproof Rating	IP68
Master Box	12 pcs

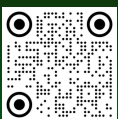

YOUTUBE VIDEO
INSTALLATION GUIDE



WEBSITE



CATALOG



(800) 360-2960



ABBALightingUSA@gmail.com



7701 Alabama Ave, Canoga Park, CA 91304

CAUTION:

FIXTURE(S) MUST BE INSTALLED IN ACCORDANCE WITH ALL LOCAL CODES AND ORDINANCES.

IMPORTANT SAFETY INFORMATION

To ensure optimal performance and safety, always use our fixtures ONLY with a low-voltage landscape transformer. This transformer reduces the voltage from 120V to 12V, making it safe and suitable for outdoor use. Failure to follow these guidelines may result in electrical hazards or damage to the fixture.



2700K

3000K

4000K



5000K

RGBCW



YOUTUBE VIDEO
INSTALLATION GUIDE



WEBSITE

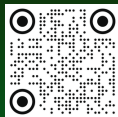

CATALOG



(800) 360-2960



ABBALightingUSA@gmail.com



7701 Alabama Ave, Canoga Park, CA 91304

INSTALLATION GUIDE FOR ULB01

STEP-BY-STEP INSTALLATION INSTRUCTIONS

Step 1: Plan Your Layout

- **Determine Placement:** Choose the path or area where the lights will be installed. Measure the distance between lights to ensure even illumination. A typical spacing is 6–10 feet apart, depending on the desired light spread.
- **Consider Power Source:** Ensure that the Fixture can be connected to a suitable power source. Ensure that the input voltage of the light cable wires is 12V AC/DC. Using improper voltage may cause malfunction or permanent damage to the fixture.

Step 2: Establish a Secure Electrical Connection

For a dependable and long-lasting electrical connection between the fixture wires and the main line in outdoor or underground installations, follow these guidelines:

- Use a direct burial-rated main cable connector designed to withstand environmental conditions, resist moisture and corrosion, and provide robust insulation.
- We recommend using WN12 waterproof wire nuts (sold separately) for optimal connectivity and protection against the elements.

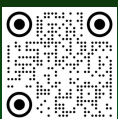

YOUTUBE VIDEO
INSTALLATION GUIDE



WEBSITE

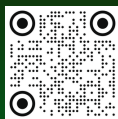

CATALOG



(800) 360-2960



ABBALightingUSA@gmail.com



7701 Alabama Ave, Canoga Park, CA 91304

INSTALLATION GUIDE FOR ULB01

Step 3: Wire Connection Instructions

Strip the insulation: Carefully strip approximately $\frac{3}{4}$ inch (1.9 cm) of insulation from the ends of the two wires to be connected. Ensure that the exposed metal ends are clean and free of frayed strands.

Align the wires: Hold the stripped ends of both wires together, making sure they are neatly aligned with no stray strands crossing over.

Twist the wire nut: Firmly twist the wire nut clockwise onto the wires until it is tight and secure.

Insert the wires into the wire nut: Push the aligned wire ends all the way into the wire nut, ensuring that the bare metal is fully covered.

Test the connection: Gently tug on each wire to ensure they are firmly held in place and will not come loose.

Inspect the connection: Ensure that no exposed wires or loose strands are visible. If the connection is not secure, remove the wire nut and repeat the process.

⚠ Note: Always follow local electrical codes and regulations when performing electrical work. If unsure or uncomfortable with electrical tasks, consult a qualified electrician. Safety should always be a top priority.

FIXTURE ASSEMBLY & INSTALLATION

Step 4: Bulb Installation

- Remove the front part from the fixture.
- Insert the appropriate bulb ensuring it is seated securely in the socket.
- Reattach the top part to the fixture, making sure it is properly aligned and fastened.

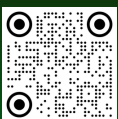

YOUTUBE VIDEO
INSTALLATION GUIDE



WEBSITE



CATALOG



(800) 360-2960



ABBALightingUSA@gmail.com



7701 Alabama Ave, Canoga Park, CA 91304

INSTALLATION GUIDE FOR ULB01

Step 5: Power On & Final Adjustments

- Turn on the power to test the fixture.
- Make any final angle adjustments to ensure optimal lighting coverage.
- Verify proper operation before completing the installation.
- Bury the main cable underground for safety and protection from external elements.
- Do not exceed the maximum wattage specified for the fixture to prevent overheating or damage.
- Regularly inspect and maintain your lighting system to ensure long-term reliability.



YOUTUBE VIDEO
INSTALLATION GUIDE



WEBSITE



CATALOG



(800) 360-2960



ABBALightingUSA@gmail.com



7701 Alabama Ave, Canoga Park, CA 91304

INSTALLATION GUIDE FOR ULB01

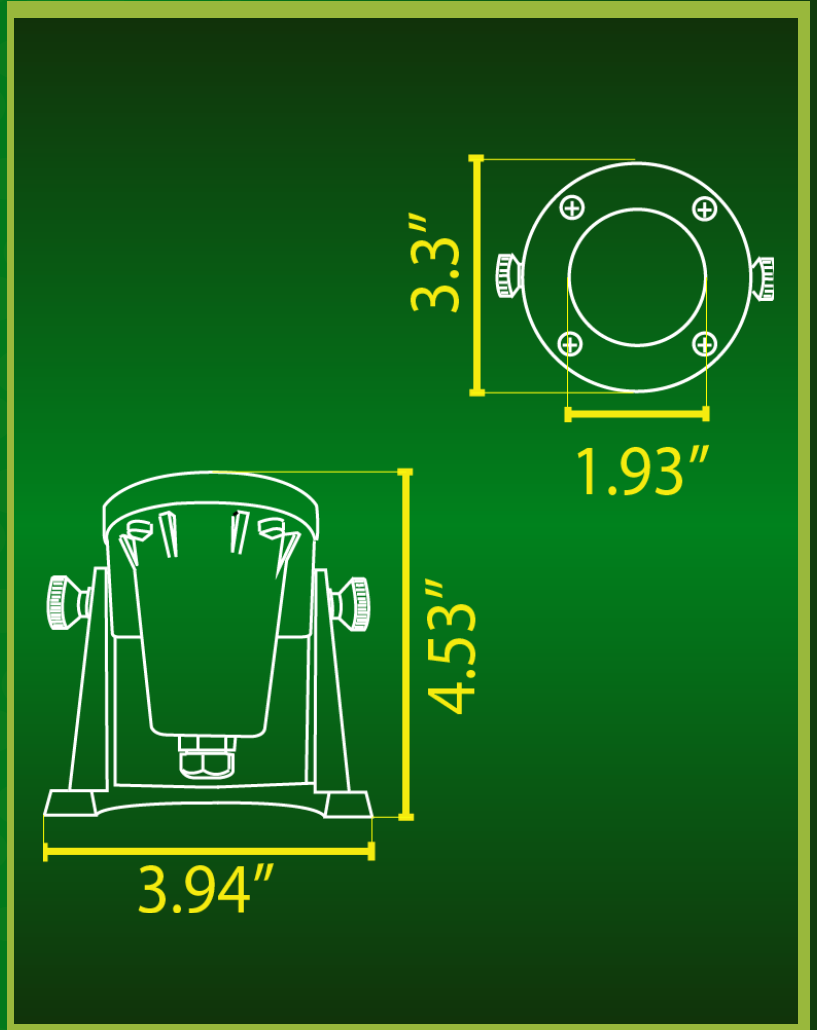

YOUTUBE VIDEO
INSTALLATION GUIDE



WEBSITE



CATALOG



(800) 360-2960



ABBALightingUSA@gmail.com



7701 Alabama Ave, Canoga Park, CA 91304

INSTALLATION GUIDE FOR ULB01

MAINTENANCE TIPS

- **Regular Inspection:** Periodically check the fixture to ensure they are still securely mounted and functioning correctly.
- **Surface Maintenance:** Monitor the mounting surface.

SAFETY PRECAUTIONS

- Always wear appropriate safety gear, such as gloves and safety glasses, during installation.
- Ensure the mounting surface is capable of supporting the weight of the lighting fixture.

ADDITIONAL RESOURCES

For a detailed video tutorial on how to install, visit our YouTube channel and search for "ULB01"

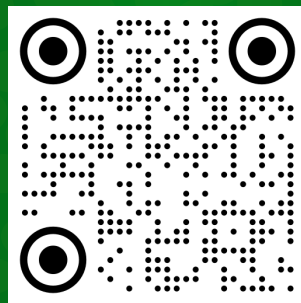

Please visit our website for more of our products.

www.ABBALightingUSA.com

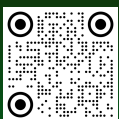

YOUTUBE VIDEO
INSTALLATION GUIDE



WEBSITE

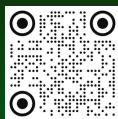

CATALOG



(800) 360-2960



ABBALightingUSA@gmail.com



7701 Alabama Ave, Canoga Park, CA 91304

ULB01

UNDERWATER LIGHT



ABBA LIGHTING USA