

UNSO! WELL LIGHT



INSTALLATION GUIDE

ABBA LIGHTING USA

UNSO1 WELL LIGHT

MR16 SOLD SEPARATELY

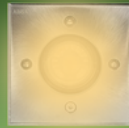

2700K



3000K



4000K



5000K



HEAVY DUTY
STAINLESS STEEL



INCLUDED:

18/2
DIRECT BURY
LANDSCAPE
LIGHTING
WIRE

FEATURE:

FIXED
INNER
BRACKET



ABBA LIGHTING USA

Thank you for choosing our high-quality product. To ensure the best possible experience, please take a moment to carefully read and follow all instructions before assembly, installation, and use. Doing so will not only guarantee proper function and safety but also help you maximize the full potential of this exceptional product. We truly appreciate your business and are honored to be your trusted provider of top-notch products!

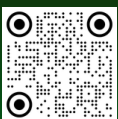

YOUTUBE VIDEO
INSTALLATION GUIDE



WEBSITE



CATALOG



(800) 360-2960



ABBALightingUSA@gmail.com



7701 Alabama Ave, Canoga Park, CA 91304

WARNING

TO REDUCE THE RISK OF FIRE OR INJURY TO PERSONS:

- ✓ Please exercise caution when using the lamp, as it tends to HEAT up rapidly. We recommend taking necessary safety measures to ensure optimal usage.
- ✓ For your safety, please refrain from touching the HOT lens, guard, or enclosure. We recommend waiting for the product to cool down before handling it.
- ✓ To prevent any fire hazards, please ensure that the lamp is kept away from materials that may easily catch fire. We appreciate your cooperation in maintaining a safe and secure environment.
- ✓ For safety reasons, we recommend that only a qualified professional install this electrical product.
- ✓ Before attempting to install this unit, ensure all power connections are off for your own safety.

WARRANTY

- We stand behind the quality of our product and offer a 2 year warranty. Kindly ensure that you keep the proof of purchase as it will be required for any warranty claims.
- Warranty will be void if there is any damage due to improper usage or modification to the fixture.
- Failure to comply with the instruction in this manual may increase the risk of damage or injury and will void warranty.



YOUTUBE VIDEO
INSTALLATION GUIDE



WEBSITE

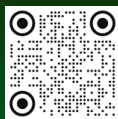

CATALOG



(800) 360-2960



ABBALightingUSA@gmail.com



7701 Alabama Ave, Canoga Park, CA 91304

CAUTION:

FIXTURE(S) MUST BE INSTALLED IN ACCORDANCE WITH ALL LOCAL CODES AND ORDINANCES.

DO NOT INSTALL WITHIN 10 FEET OF A POOL, SPA OR FOUNTAIN

UNS01 Square Stainless Steel Well Light

12V MR16 Low-Voltage | Heavy-Duty Stainless Steel | IP65 Outdoor Rated

The UNS01 Square Well Light by Abba Lighting USA is a robust, architectural-grade in-ground luminaire designed to integrate seamlessly with modern landscapes. Its clean, flush-mounted square housing and premium materials provide sophisticated uplighting for trees, walls, pillars, or entryways—while maintaining a sleek, unobtrusive presence.

Premium Build & Aesthetic Craftsmanship

Solid Stainless Steel Construction

The fixture's heavy-duty 304 stainless steel enclosure resists corrosion and tarnishing, ensuring long-term durability in outdoor environments. Available in either a polished steel or black finish to complement any design palette.

Flush Modern Design

Measuring 4.3" × 4.3" × 4.7" (L×W×H), it sits flush against the surface with minimal visibility—highlighting architectural form rather than the light source.

Flexible Lighting with MR16 Compatibility

MR16 Lamp Ready

The UNS01 accommodates 12V MR16 LED bulbs (sold separately), including warm white (3000K) and color options (red, blue, green), allowing users to personalize mood and effect.



YOUTUBE VIDEO
INSTALLATION GUIDE



WEBSITE

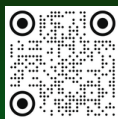

CATALOG



(800) 360-2960



ABBALightingUSA@gmail.com



7701 Alabama Ave, Canoga Park, CA 91304

CAUTION:

FIXTURE(S) MUST BE INSTALLED IN ACCORDANCE WITH ALL LOCAL CODES AND ORDINANCES.

DO NOT INSTALL WITHIN 10 FEET OF A POOL, SPA OR FOUNTAIN

Cozy Ambient Illumination

When paired with a 3000 K MR16 LED, it casts a welcoming, soft-toned glow—ideal for accentuating trees, and architectural features.

Reliable Weather Protection & Installation Ease

IP65 Waterproofing

Designed to resist rain, dust, and outdoor conditions with an IP65 rating for dependable performance in all climates.

Inner Bracket Included

Supplies an fixed inner bracket to secure bulb orientation for precise light aiming and hassle-free installation.

Pre-Wired Lead

Features a pre-stripped wire for straightforward connection to compatible 12V landscaping systems.



YOUTUBE VIDEO
INSTALLATION GUIDE



WEBSITE

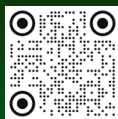

CATALOG



(800) 360-2960



ABBALightingUSA@gmail.com



7701 Alabama Ave, Canoga Park, CA 91304

CAUTION:

FIXTURE(S) MUST BE INSTALLED IN ACCORDANCE WITH ALL LOCAL CODES AND ORDINANCES.

DO NOT INSTALL WITHIN 10 FEET OF A POOL, SPA OR FOUNTAIN

Technical Specifications

Material: 304 Stainless Steel (Black or Stainless Steel)

Dimensions :4.3" × 4.3" × 4.7" (L×W×H)





Bulb Compatibility: MR16 LED 12V (not included)—warm white/color blends

Voltage: 12V AC/DC Low-Voltage

Waterproof Rating: IP65 – Outdoor Rated

Included: Adjustable inner bracket for bulb positioning

Ideal Applications

-  Pathways & Walkways
- Provide safe and stylish lighting to footpaths or stone walkways by casting bi-directional beams along each side.
-  Garden Borders
- Define planting beds or hedges with a clean lighting line that highlights both directions equally.
-  Commercial Landscapes
- Use in upscale developments, hotels, or gated communities where architectural symmetry and lighting discipline are essential.
-  Driveways & Entryways
- Highlight drive borders, stone pavers, or columns from ground level without causing upward glare.
-  Fences & Hardscape Edges
- Perfect for illuminating the base of walls, fences, or retaining structures from both sides simult



YOUTUBE VIDEO
INSTALLATION GUIDE



WEBSITE



CATALOG



(800) 360-2960



ABBALightingUSA@gmail.com



7701 Alabama Ave, Canoga Park, CA 91304

CAUTION:

FIXTURE(S) MUST BE INSTALLED IN ACCORDANCE WITH ALL LOCAL CODES AND ORDINANCES.

DO NOT INSTALL WITHIN 10 FEET OF A POOL, SPA OR FOUNTAIN

Why Choose the UNS01?

The UNS01 offers a sophisticated, high-performance lighting solution tailored for discerning designers, contractors, and homeowners. Its heavy-gauge stainless steel housing ensures enduring quality, while its flush, geometric form offers elegant lighting without visual clutter. MR16 lamp flexibility allows artistic light choice—making it a refined addition to upscale landscapes or commercial outdoor projects.

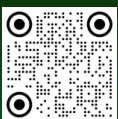

YOUTUBE VIDEO
INSTALLATION GUIDE



WEBSITE



CATALOG



(800) 360-2960



ABBALightingUSA@gmail.com



7701 Alabama Ave, Canoga Park, CA 91304

CAUTION:

FIXTURE(S) MUST BE INSTALLED IN ACCORDANCE WITH ALL LOCAL CODES AND ORDINANCES.

DO NOT INSTALL WITHIN 10 FEET OF A POOL, SPA OR FOUNTAIN

STEP-BY-STEP INSTALLATION INSTRUCTIONS

Safety Precautions

- Ensure the power supply is turned off before installation.
- Follow local electrical codes and regulations.
- Wear protective gloves during installation to avoid injury.
- Do not install in areas prone to excessive moisture unless properly sealed.
- Ensure all connections are waterproof for outdoor installations.

1. Preparing the Installation

- Select a location that provides the best illumination while avoiding areas prone to standing water.
- If installing in-ground, dig a hole large enough to accommodate the fixture and the wiring.
- If installing in concrete or hard surfaces, ensure proper mounting sleeves or junction boxes are available.
- Remove the screws from the top cover of the fixture. Carefully take off the glass lens along with the rubber seal. Install the MR16 bulb by securing the screws into the designated slots on the bulb. Once the bulb is in place, reposition the glass lens with the rubber seal, then reattach the top cover and tighten the screws to secure it

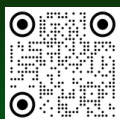

YOUTUBE VIDEO
INSTALLATION GUIDE



WEBSITE



CATALOG



(800) 360-2960



ABBALightingUSA@gmail.com



7701 Alabama Ave, Canoga Park, CA 91304

INSTALLATION GUIDE FOR UNS01

2. Wiring Connections

- Turn off the power at the main electrical panel.
- Connect the fixture's low-voltage wires to the main power supply using the provided connectors. Use WN12 (Sold Separately) to Waterproof your connection.
- Secure all wire connections and test for continuity before final installation.
- Use waterproof electrical tape or silicone sealant to protect connections from moisture.

3. Fixture Installation

For In-Ground Installation:

- Place the fixture into the prepared hole.
- Insert the fixture into the sleeve, ensuring it is level and secure
- Use gravel and soil for additional stability.

For Concrete/Hard Surface Installation:

- Secure the fixture using mounting brackets or embedded housing.
- Ensure the fixture is flush with the surface for a clean, professional look.



YOUTUBE VIDEO
INSTALLATION GUIDE



WEBSITE

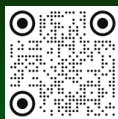

CATALOG



(800) 360-2960



ABBALightingUSA@gmail.com



7701 Alabama Ave, Canoga Park, CA 91304

INSTALLATION GUIDE FOR UNS01

CONCRETE

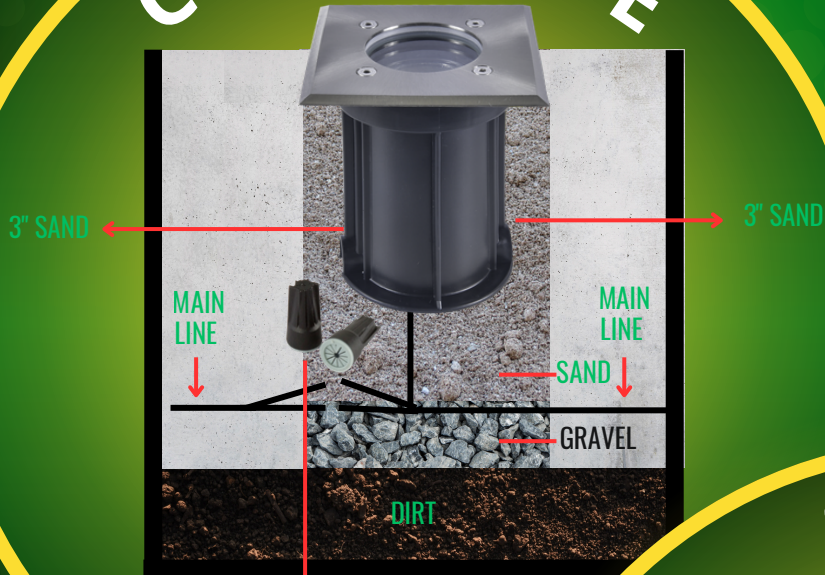

WN12 WATERPROOF
WIRE NUTS
(SOLD SEPARATELY)

Leave a 3-inch clearance around the fixture and place gravel at the bottom to ensure proper drainage. This prevents water from accumulating around the fixture body and helps avoid water ingress, even though the fixture is IP65 rated.

SOIL

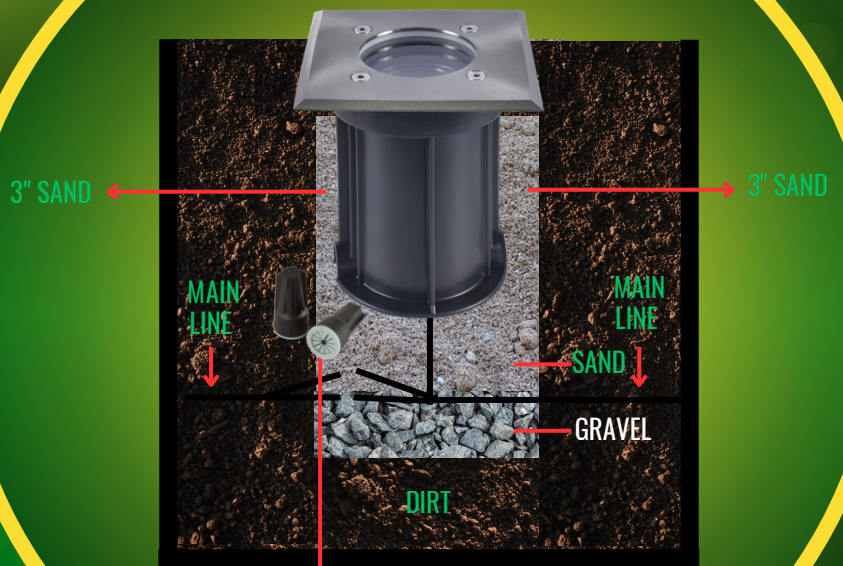

WN12 WATERPROOF
WIRE NUTS
(SOLD SEPARATELY)



YOUTUBE VIDEO
INSTALLATION GUIDE



WEBSITE



CATALOG



(800) 360-2960



ABBALightingUSA@gmail.com



7701 Alabama Ave, Canoga Park, CA 91304

INSTALLATION GUIDE FOR UNS01

FIXTURE TOP ANGLE

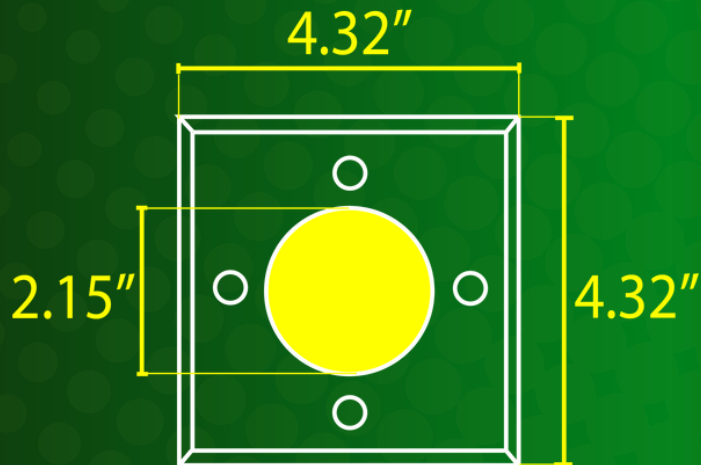

FIXTURE SIDE ANGLE

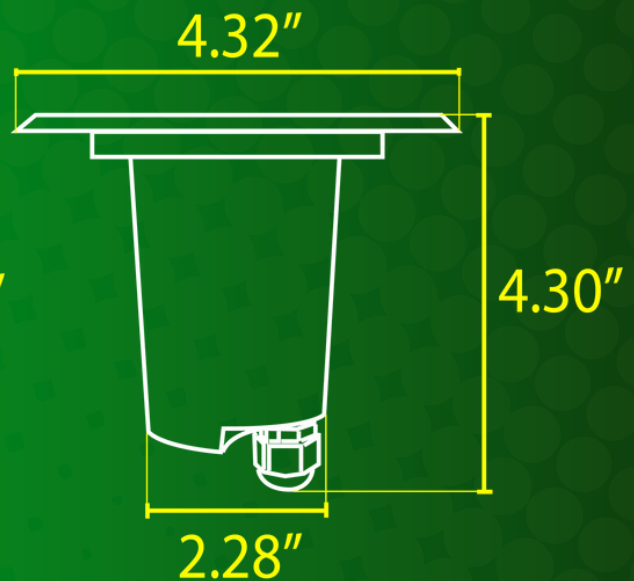

FIXTURE WITH CASE

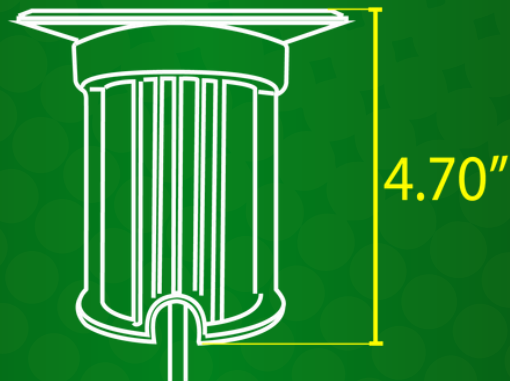

YOUTUBE VIDEO
INSTALLATION GUIDE



WEBSITE



CATALOG



(800) 360-2960



ABBALightingUSA@gmail.com



7701 Alabama Ave, Canoga Park, CA 91304

INSTALLATION GUIDE FOR UNS01

MAINTENANCE TIPS

- **Regular Inspection:** Periodically check the bracket and fixture to ensure they are still securely mounted and functioning correctly.

SAFETY PRECAUTIONS

- Always wear appropriate safety gear, such as gloves and safety glasses, during installation.
- Ensure the mounting surface is capable of supporting the weight of both the bracket and the lighting fixture.

ADDITIONAL RESOURCES

For a detailed video tutorial on how to install, visit our YouTube channel and search for "UNS01"

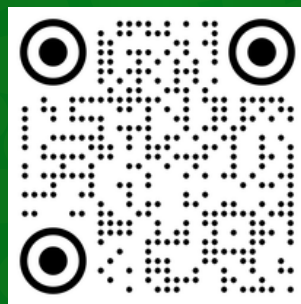

Please visit our website for more of our products.

www.ABBALightingUSA.com

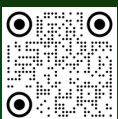

YOUTUBE VIDEO
INSTALLATION GUIDE



WEBSITE

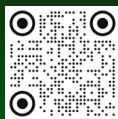

CATALOG



(800) 360-2960



ABBALightingUSA@gmail.com



7701 Alabama Ave, Canoga Park, CA 91304

UNSO1

WELL LIGHT

