

# ABBA

SPOT LIGHT

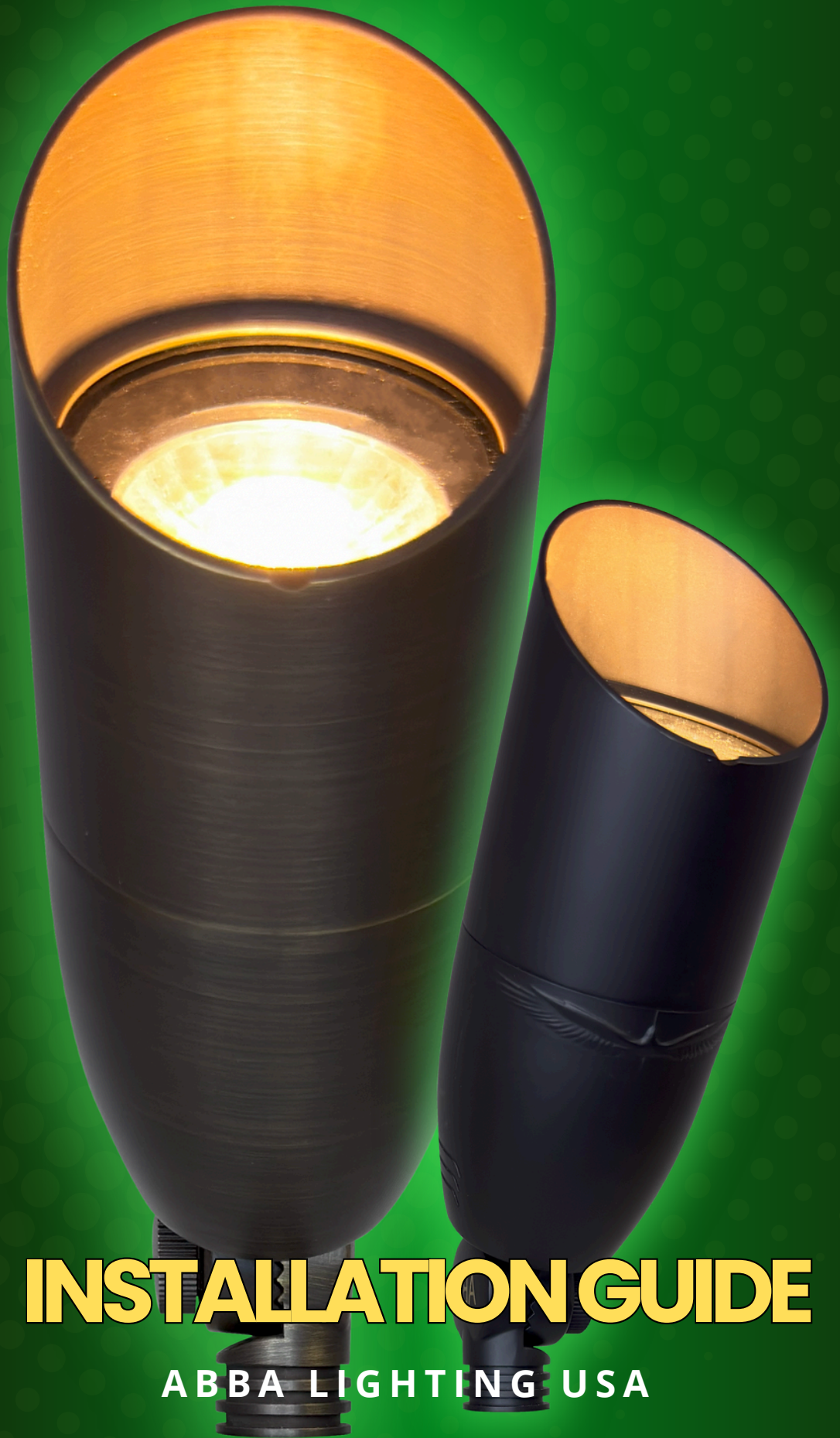

## INSTALLATION GUIDE

ABBA LIGHTING USA

# ABBA

SPOT LIGHT



**HEAVY DUTY  
CAST  
BRASS**

## FINISH

Natural Brass

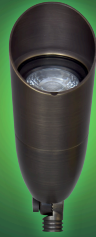

Dark Brass



# SPB3

SPOT LIGHT



ABS  
GROUND  
SPIKE  
INCLUDED

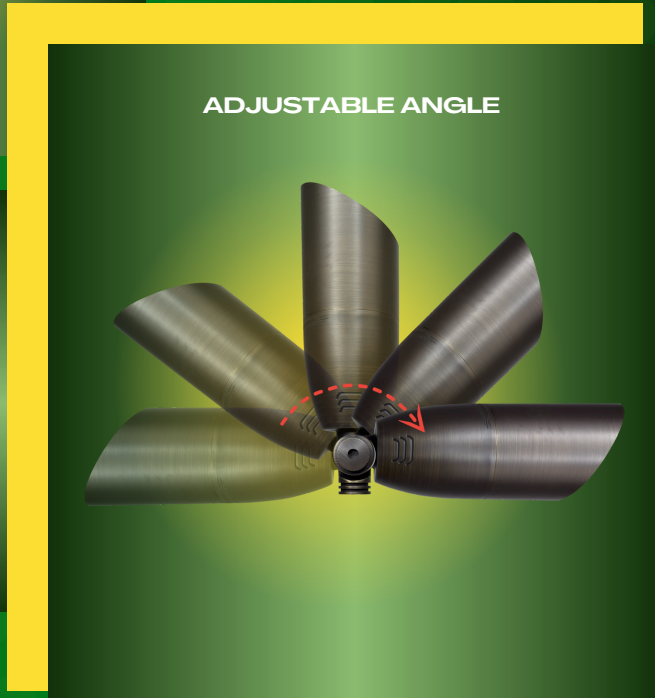

ADJUSTABLE ANGLE

# SPOT LIGHT



Thank you for choosing our high-quality product. To ensure the best possible experience, please take a moment to carefully read and follow all instructions before assembly, installation, and use. Doing so will not only guarantee proper function and safety but also help you maximize the full potential of this exceptional product. We truly appreciate your business and are honored to be your trusted provider of top-notch products!



YOUTUBE VIDEO  
INSTALLATION GUIDE



WEBSITE



CATALOG



(800) 360-2960



ABBALightingUSA@gmail.com



7701 Alabama Ave, Canoga Park, CA 91304

# WARNING

## TO REDUCE THE RISK OF FIRE OR INJURY TO PERSONS:

- ✔ Please exercise caution when using the lamp, as it tends to HEAT up rapidly. We recommend taking necessary safety measures to ensure optimal usage.
- ✔ For your safety, please refrain from touching the HOT lens, guard, or enclosure. We recommend waiting for the product to cool down before handling it.
- ✔ To prevent any fire hazards, please ensure that the lamp is kept away from materials that may easily catch fire. We appreciate your cooperation in maintaining a safe and secure environment.
- ✔ For safety reasons, we recommend that only a qualified professional install this electrical product.
- ✔ Before attempting to install this unit, ensure all power connections are off for your own safety.

# WARRANTY

- We stand behind the quality of our product and offer a 3 Year warranty. Kindly ensure that you keep the proof of purchase as it will be required for any warranty claims.
- Warranty will be void if there is any damage due to improper usage or modification to the fixture.
- Failure to comply with the instruction in this manual may increase the risk of damage or injury and will void warranty.



YOUTUBE VIDEO  
INSTALLATION GUIDE



WEBSITE



CATALOG



(800) 360-2960



ABBALightingUSA@gmail.com



7701 Alabama Ave, Canoga Park, CA 91304

# CAUTION:

**FIXTURE(S) MUST BE INSTALLED IN ACCORDANCE WITH ALL LOCAL CODES AND ORDINANCES.**

**DO NOT INSTALL WITHIN 10 FEET OF A POOL, SPA OR FOUNTAIN**

## PRODUCT OVERVIEW

Bring precision, durability, and timeless elegance to your landscape design with the SPB13 Integrated Brass Spot Light—a professional-grade fixture engineered with an adjustable wattage range of 3W to 12W, giving you complete control over brightness and energy consumption. Constructed from solid cast brass and equipped with a built-in LED module, this low-voltage spotlight offers architectural-grade performance ideal for uplighting trees, walls, sculptures, and other outdoor focal points. Whether for residential charm or commercial prestige, the SPB13 is built to deliver unmatched style and reliability in any environment.

## KEY FEATURES & BENEFITS

### Adjustable Wattage (3W–12W) Integrated LED

Designed for flexibility, the SPB13 features an integrated LED module with selectable wattage from 3 watts up to 12 watts. This allows lighting designers and installers to fine-tune brightness levels to fit the application—providing anything from subtle accent lighting to high-output architectural illumination, all while using energy-efficient technology.

### Solid Cast Brass for Timeless Performance

Crafted from premium-grade cast brass, this fixture is corrosion-resistant and extremely durable—ideal for long-term use in exposed outdoor environments. Over time, the brass naturally develops a rich patina, enhancing the fixture's character while maintaining structural integrity.

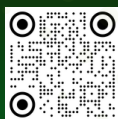

YOUTUBE VIDEO  
INSTALLATION GUIDE



WEBSITE

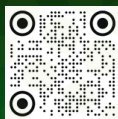

CATALOG



(800) 360-2960



ABBALightingUSA@gmail.com



7701 Alabama Ave, Canoga Park, CA 91304

# CAUTION:

**FIXTURE(S) MUST BE INSTALLED IN ACCORDANCE WITH ALL LOCAL CODES AND ORDINANCES.**

**DO NOT INSTALL WITHIN 10 FEET OF A POOL, SPA OR FOUNTAIN**

## IP65 Weatherproof for Harsh Outdoor Conditions

Engineered for performance in all seasons, the SPB13 boasts an IP65 rating, offering complete protection from dust, rain, and moisture. Whether you're lighting near water features, under trees, or in coastal regions, this spotlight performs reliably year-round.

## Quick Installation with Ground Spike & Pre-Wired Leads

This fixture comes ready for installation with an 8" heavy-duty ground spike and pre-wired leads, streamlining setup for contractors and DIY homeowners alike. The adjustable head ensures you can direct light exactly where needed.

## IDEAL APPLICATIONS

- Highlighting trees, shrubs, and garden features
- Illuminating architectural elements and facades
- Accent lighting for pathways and walkways
- Enhancing outdoor living spaces like patios and decks
- Adding security lighting around entrances and driveways



YOUTUBE VIDEO  
INSTALLATION GUIDE



WEBSITE



CATALOG



(800) 360-2960



ABBALightingUSA@gmail.com



7701 Alabama Ave, Canoga Park, CA 91304

# CAUTION:

**FIXTURE(S) MUST BE INSTALLED IN ACCORDANCE WITH ALL LOCAL CODES AND ORDINANCES.**

**DO NOT INSTALL WITHIN 10 FEET OF A POOL, SPA OR FOUNTAIN**

## Pathway & Driveway Lighting:

- Improve visibility and safety along walkways, driveways, and entry points with well-placed spot lighting.

## Security & Safety Lighting:

- Enhance security by illuminating dark areas around your property, deterring intruders and improving nighttime visibility.

## TECHNICAL SPECIFICATIONS

- Material: Solid Cast Brass
- Finish Options: Natural Brass/ Dark Brass
- Power: Adjustable wattage 3W - 12W
- Voltage: 12V Low Voltage
- Waterproof Rating: IP65
- Installation: Includes ABS ground spike for easy installation

## IMPORTANT SAFETY INFORMATION

To ensure optimal performance and safety, always use our fixtures ONLY with a low-voltage landscape transformer. This transformer reduces the voltage from 120V to 12V, making it safe and suitable for outdoor use. Failure to follow these guidelines may result in electrical hazards or damage to the fixture.

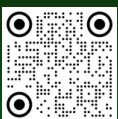

YOUTUBE VIDEO  
INSTALLATION GUIDE



WEBSITE



CATALOG



(800) 360-2960



ABBALightingUSA@gmail.com



7701 Alabama Ave, Canoga Park, CA 91304

# INSTALLATION GUIDE FOR SPB13

## STEP-BY-STEP INSTALLATION INSTRUCTIONS

### Step 1: Plan Your Layout

- **Determine Placement:** Choose the path or area where the lights will be installed. Measure the distance between lights to ensure even illumination. A typical spacing is 6–10 feet apart, depending on the desired light spread.
- **Consider Power Source:** Ensure that the Spotlight can be connected to a suitable power source. Ensure that the input voltage of the light cable wires is 12V AC/DC. Using improper voltage may cause malfunction or permanent damage to the fixture.

### Step 2: Prepare the Ground

- **Dig the Hole:** Using a shovel or trowel, dig a hole where you want to install the Spotlight. The hole should be deep enough to accommodate the ground stake.
- **Ensure Stability:** Make sure the hole is wide enough to allow the ground stake to sit firmly. Test-fit the stake by inserting it into the hole to ensure stability before proceeding.

### Step 3: Establish a Secure Electrical Connection

**For a dependable and long-lasting electrical connection between the fixture wires and the main line in outdoor or underground installations, follow these guidelines:**

- Use a direct burial-rated main cable connector designed to withstand environmental conditions, resist moisture and corrosion, and provide robust insulation.
- We recommend using WN12 waterproof wire nuts (sold separately) for optimal connectivity and protection against the elements.



YOUTUBE VIDEO  
INSTALLATION GUIDE



WEBSITE

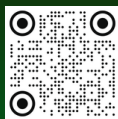

CATALOG



(800) 360-2960



ABBALightingUSA@gmail.com



7701 Alabama Ave, Canoga Park, CA 91304

# INSTALLATION GUIDE FOR SPB13

## Step 4: Wire Connection Instructions

**Strip the insulation:** Carefully strip approximately  $\frac{3}{4}$  inch (1.9 cm) of insulation from the ends of the two wires to be connected. Ensure that the exposed metal ends are clean and free of frayed strands.

**Align the wires:** Hold the stripped ends of both wires together, making sure they are neatly aligned with no stray strands crossing over.

**Twist the wire nut:** Firmly twist the wire nut clockwise onto the wires until it is tight and secure.

Insert the wires into the wire nut: Push the aligned wire ends all the way into the wire nut, ensuring that the bare metal is fully covered.

**Test the connection:** Gently tug on each wire to ensure they are firmly held in place and will not come loose.

**Inspect the connection:** Ensure that no exposed wires or loose strands are visible. If the connection is not secure, remove the wire nut and repeat the process.

**⚠ Note:** Always follow local electrical codes and regulations when performing electrical work. If unsure or uncomfortable with electrical tasks, consult a qualified electrician. Safety should always be a top priority.

## FIXTURE ASSEMBLY & INSTALLATION

### Step 5: Setting the wattage

- Remove the top part from the fixture turning counter clockwise.
- Remove the housing of the bulb by turning counter clockwise.
- Select your desired wattage setting as shown.



YOUTUBE VIDEO  
INSTALLATION GUIDE



WEBSITE



CATALOG



(800) 360-2960



ABBALightingUSA@gmail.com



7701 Alabama Ave, Canoga Park, CA 91304

# INSTALLATION GUIDE FOR SPB13

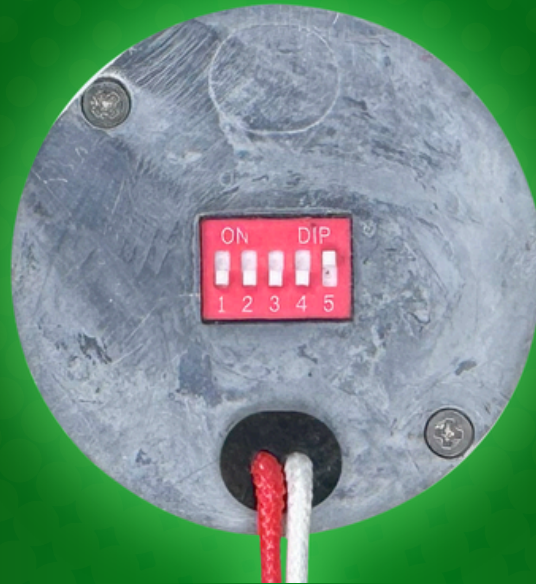

Adjust the light output by raising the desired number of pins, as shown:

- 1 pin up → 240 lm
- 2 pins up → 380 lm
- 3 pins up → 385 lm
- 4 pins up → 674 lm
- 5 pins up → 970 lm

Reattach the top part to the fixture, making sure it is properly aligned and fastened.



YOUTUBE VIDEO  
INSTALLATION GUIDE



WEBSITE



CATALOG



(800) 360-2960



ABBALightingUSA@gmail.com



7701 Alabama Ave, Canoga Park, CA 91304

# INSTALLATION GUIDE FOR SPB13

## Step 6: Mounting the Fixture

- Insert the spike mount into the ground, ensuring it is vertical and stable for proper positioning.
- Adjust the light angle as needed to achieve the desired illumination.

## Step 7: Power On & Final Adjustments

- Turn on the power to test the fixture.
- Make any final angle adjustments to ensure optimal lighting coverage.
- Verify proper operation before completing the installation.
- Bury the main cable underground for safety and protection from external elements.
- Do not exceed the maximum wattage specified for the fixture to prevent overheating or damage.
- Regularly inspect and maintain your lighting system to ensure long-term reliability.



YOUTUBE VIDEO  
INSTALLATION GUIDE



WEBSITE



CATALOG



(800) 360-2960



ABBALightingUSA@gmail.com



7701 Alabama Ave, Canoga Park, CA 91304

# INSTALLATION GUIDE FOR SPB13

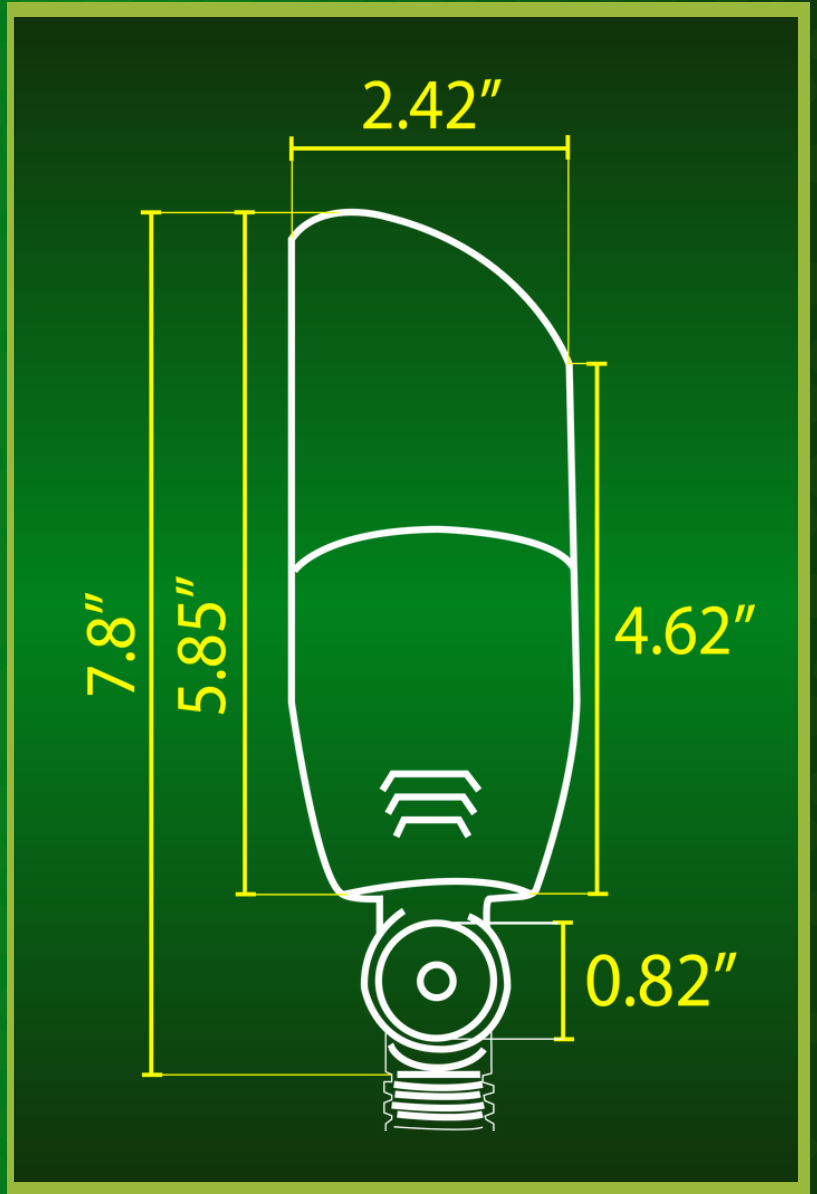

YOUTUBE VIDEO  
INSTALLATION GUIDE



WEBSITE



CATALOG



(800) 360-2960



ABBALightingUSA@gmail.com



7701 Alabama Ave, Canoga Park, CA 91304

# INSTALLATION GUIDE FOR SPB13

## MAINTENANCE TIPS

- **Regular Inspection:** Periodically check the bracket and fixture to ensure they are still securely mounted and functioning correctly.
- **Surface Maintenance:** Monitor the mounting surface, particularly trees, to ensure the bracket does not cause damage as the tree grows.

## SAFETY PRECAUTIONS

- Always wear appropriate safety gear, such as gloves and safety glasses, during installation.
- Ensure the mounting surface is capable of supporting the weight of both the bracket and the lighting fixture.

## ADDITIONAL RESOURCES

For a detailed video tutorial on how to install, visit our YouTube channel and search for "SPB13"

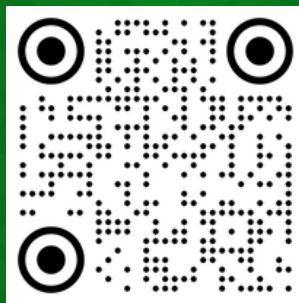

Please visit our website for more of our products.

[www.ABBALightingUSA.com](http://www.ABBALightingUSA.com)

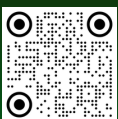

YOUTUBE VIDEO  
INSTALLATION GUIDE



WEBSITE

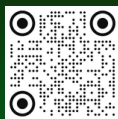

CATALOG



(800) 360-2960



ABBALightingUSA@gmail.com



7701 Alabama Ave, Canoga Park, CA 91304

# SPBT13

SPOT LIGHT



ABBA

ABBA LIGHTING USA