

SPBT

SPOT LIGHT



INSTALLATION GUIDE

ABBA LIGHTING USA

SPBT

SPOT LIGHT



**HEAVY DUTY
CAST
BRASS**

FINISH

Natural Brass



Dark Brass



**BULB:
MR11**

SPBT SPOT LIGHT



SPOT LIGHT



Thank you for choosing our high-quality product. To ensure the best possible experience, please take a moment to carefully read and follow all instructions before assembly, installation, and use. Doing so will not only guarantee proper function and safety but also help you maximize the full potential of this exceptional product. We truly appreciate your business and are honored to be your trusted provider of top-notch products!



YOUTUBE VIDEO
INSTALLATION GUIDE



WEBSITE



CATALOG



(800) 360-2960



ABBALightingUSA@gmail.com



7701 Alabama Ave, Canoga Park, CA 91304

WARNING

TO REDUCE THE RISK OF FIRE OR INJURY TO PERSONS:

- ✓ Please exercise caution when using the lamp, as it tends to HEAT up rapidly. We recommend taking necessary safety measures to ensure optimal usage.
- ✓ For your safety, please refrain from touching the HOT lens, guard, or enclosure. We recommend waiting for the product to cool down before handling it.
- ✓ To prevent any fire hazards, please ensure that the lamp is kept away from materials that may easily catch fire. We appreciate your cooperation in maintaining a safe and secure environment.
- ✓ For safety reasons, we recommend that only a qualified professional install this electrical product.
- ✓ Before attempting to install this unit, ensure all power connections are off for your own safety.

WARRANTY

- We stand behind the quality of our product and offer a 3 Year warranty. Kindly ensure that you keep the proof of purchase as it will be required for any warranty claims.
- Warranty will be void if there is any damage due to improper usage or modification to the fixture.
- Failure to comply with the instruction in this manual may increase the risk of damage or injury and will void warranty.



YOUTUBE VIDEO
INSTALLATION GUIDE



WEBSITE



CATALOG



(800) 360-2960



ABBALightingUSA@gmail.com



7701 Alabama Ave, Canoga Park, CA 91304

CAUTION:

FIXTURE(S) MUST BE INSTALLED IN ACCORDANCE WITH ALL LOCAL CODES AND ORDINANCES.

DO NOT INSTALL WITHIN 10 FEET OF A POOL, SPA OR FOUNTAIN

PRODUCT OVERVIEW

Bring elegant, targeted illumination to your landscape with the SPB11 Brass Spot Light from Abba Lighting USA—a premium-grade, low-voltage lighting solution crafted with uncompromising quality and refined aesthetics. Engineered for outdoor performance and designed to elevate the visual appeal of any landscape environment, the SPB11 combines cast brass construction, IP65-rated weather resistance, and versatile MR11 LED compatibility in one sleek, compact fixture.

Ideal for professional landscape contractors, lighting designers, and discerning homeowners, the SPB11 is the perfect choice for accentuating architectural details, illuminating plants and trees, or highlighting outdoor pathways and water features—all while maintaining a subtle and polished presence in your landscape design.

KEY FEATURES & BENEFITS

Timeless Craftsmanship with Superior Durability

Built to last in all climates, the SPB11 is constructed from solid cast brass, ensuring unmatched strength, corrosion resistance, and thermal stability. Unlike cheaper aluminum or plastic fixtures that fade, crack, or corrode over time, this fixture maintains both its form and function for years—even in coastal or humid environments.

Available in two elegant finishes—Natural Brass and Dark Brass—this fixture seamlessly integrates into traditional or modern outdoor aesthetics. Over time, the brass naturally ages into a sophisticated patina, enhancing the rustic charm of your landscape without compromising performance.



YOUTUBE VIDEO
INSTALLATION GUIDE



WEBSITE



CATALOG



(800) 360-2960



ABBALightingUSA@gmail.com



7701 Alabama Ave, Canoga Park, CA 91304

CAUTION:

FIXTURE(S) MUST BE INSTALLED IN ACCORDANCE WITH ALL LOCAL CODES AND ORDINANCES.

DO NOT INSTALL WITHIN 10 FEET OF A POOL, SPA OR FOUNTAIN

Compact, Focused Illumination with MR11 Versatility

The SPB11 is engineered to deliver focused and efficient lighting output using a standard MR11 LED bulb (not included). This design provides flexibility in lumen output and beam angle—allowing you to fine-tune your lighting scheme based on the project needs.

Choose from compatible MR11 LED lamps in:

- 2W or higher, depending on transformer capacity and desired intensity
- 3000K Warm White for ambient, inviting glow
- 5000K Cool White for vibrant and modern visibility

Its narrow beam spread is ideal for creating dramatic uplighting effects on garden sculptures, trees, signage, retaining walls, entryways, or architectural columns—allowing you to draw attention exactly where it's needed, without light spill or glare.

IP65 Weatherproof Protection for Year-Round Operation

Rated IP65 waterproof, the SPB11 is fully sealed against dust, moisture, and rain, making it suitable for installation in all outdoor conditions. Whether it's installed in a desert, coastal, or tropical region, you can expect dependable year-round illumination without performance degradation.

Effortless Installation with Landscape-Friendly Mounting

Designed with convenience in mind, the SPB11 includes a durable ABS ground spike for fast and stable mounting in soil, mulch, gravel, or turf. Its compact dimensions—approximately 5 to 7 inches tall with a 2.25-inch head—make it perfect for concealed installations, where subtlety is key.



YOUTUBE VIDEO
INSTALLATION GUIDE

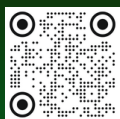

WEBSITE



CATALOG



(800) 360-2960



ABBALightingUSA@gmail.com



7701 Alabama Ave, Canoga Park, CA 91304

CAUTION:





FIXTURE(S) MUST BE INSTALLED IN ACCORDANCE WITH ALL LOCAL CODES AND ORDINANCES.

DO NOT INSTALL WITHIN 10 FEET OF A POOL, SPA OR FOUNTAIN

Compatible with standard 12V AC/DC low-voltage landscape transformers, this fixture is easy to wire into existing systems using high-quality waterproof connectors such as WN12 wire nuts (sold separately). The pre-stripped leads make wiring fast and reliable, reducing labor time while ensuring a secure electrical connection.

Ideal Applications

Whether you're a homeowner upgrading your garden lighting or a professional contractor completing a large-scale estate project, the SPB11 is tailored for a wide range of applications:

Application Type	Example Use-Cases
 Uplighting	Trees, columns, statues, water features, pillars, walls
 Architectural Highlighting	Home facades, archways, textures, stonework, entryways
 Landscape Accents	Flower beds, boulders, garden art, yard signage
 Hardscape Integration	Retaining walls, step risers, patio edges, pool decks
 Residential or Commercial	Driveways, office grounds, courtyards, perimeter paths, and custom installations

Its small form factor and clean aesthetic make it especially suited for projects where discreet lighting is preferred without sacrificing output or beam control.

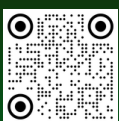

YOUTUBE VIDEO
INSTALLATION GUIDE



WEBSITE

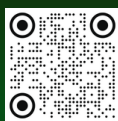

CATALOG



(800) 360-2960



ABBALightingUSA@gmail.com



7701 Alabama Ave, Canoga Park, CA 91304

CAUTION:

FIXTURE(S) MUST BE INSTALLED IN ACCORDANCE WITH ALL LOCAL CODES AND ORDINANCES.

DO NOT INSTALL WITHIN 10 FEET OF A POOL, SPA OR FOUNTAIN

Feature	Details
Material	Solid Cast Brass
Finish Options	Natural Brass / Dark Brass
Bulb Type	MR11 LED (12V) – Not Included
Compatible Wattage	Typically 2W or higher (Check transformer capacity)
Color Temperature	2700K/3000K/4000K 5000K
Input Voltage	12V AC/DC
Weatherproof Rating	IP65 Rated for Outdoor Use
Dimensions	Approx. 5-7" H × 2.25" W × 1.6" L
Mounting	ABS Ground Spike (Included)
Installation Environment	Outdoor – Residential, Commercial, or Architectural Landscape Applications
Wiring Accessories	WN12 Waterproof Wire Nuts (Recommended, Sold Separately)

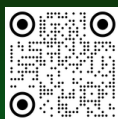

YOUTUBE VIDEO
INSTALLATION GUIDE



WEBSITE

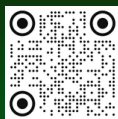

CATALOG



(800) 360-2960



ABBALightingUSA@gmail.com



7701 Alabama Ave, Canoga Park, CA 91304

CAUTION:

FIXTURE(S) MUST BE INSTALLED IN ACCORDANCE WITH ALL LOCAL CODES AND ORDINANCES.

DO NOT INSTALL WITHIN 10 FEET OF A POOL, SPA OR FOUNTAIN

Why Choose the SPB11 from Abba Lighting USA?

- Long-Term Performance – Built from brass, not plastic. Designed to outlast seasonal fixtures.
- Professional-Grade Aesthetics – Clean lines and elegant materials that match luxury properties.
- Installer Friendly – Plug-and-play wiring design, universal MR11 compatibility, and spike mount.
- Energy-Efficient – Pair with low-wattage MR11 LEDs to maximize efficiency on any low-voltage system.

Installation Tips for Professionals

- Use only with a low-voltage 12V transformer—never connect directly to 120V.
- Always bury low-voltage wire at least 6 inches below grade or run through conduit for protection.
- Position the fixture so the beam does not cause light trespass on neighboring properties.
- For longer cable runs, calculate voltage drop and choose appropriate wire gauge.
- Recommend clients install a photocell or timer for automatic dusk-to-dawn control.

IMPORTANT SAFETY INFORMATION

To ensure optimal performance and safety, always use our fixtures ONLY with a low-voltage landscape transformer. This transformer reduces the voltage from 120V to 12V, making it safe and suitable for outdoor use. Failure to follow these guidelines may result in electrical hazards or damage to the fixture.



YOUTUBE VIDEO
INSTALLATION GUIDE



WEBSITE



CATALOG



(800) 360-2960



ABBALightingUSA@gmail.com



7701 Alabama Ave, Canoga Park, CA 91304

INSTALLATION GUIDE FOR SPB11

STEP-BY-STEP INSTALLATION INSTRUCTIONS

Step 1: Plan Your Layout

- **Determine Placement:** Choose the path or area where the lights will be installed. Measure the distance between lights to ensure even illumination. A typical spacing is 6–10 feet apart, depending on the desired light spread.
- **Consider Power Source:** Ensure that the Spotlight can be connected to a suitable power source. Ensure that the input voltage of the light cable wires is 12V AC/DC. Using improper voltage may cause malfunction or permanent damage to the fixture.

Step 2: Prepare the Ground

- **Dig the Hole:** Using a shovel or trowel, dig a hole where you want to install the Spotlight. The hole should be deep enough to accommodate the ground stake.
- **Ensure Stability:** Make sure the hole is wide enough to allow the ground stake to sit firmly. Test-fit the stake by inserting it into the hole to ensure stability before proceeding.

Step 3: Establish a Secure Electrical Connection

For a dependable and long-lasting electrical connection between the fixture wires and the main line in outdoor or underground installations, follow these guidelines:

- Use a direct burial-rated main cable connector designed to withstand environmental conditions, resist moisture and corrosion, and provide robust insulation.
- We recommend using WN12 waterproof wire nuts (sold separately) for optimal connectivity and protection against the elements.



YOUTUBE VIDEO
INSTALLATION GUIDE



WEBSITE



CATALOG



(800) 360-2960



ABBALightingUSA@gmail.com



7701 Alabama Ave, Canoga Park, CA 91304

INSTALLATION GUIDE FOR SPB11

Step 4: Wire Connection Instructions

Strip the insulation: Carefully strip approximately $\frac{3}{4}$ inch (1.9 cm) of insulation from the ends of the two wires to be connected. Ensure that the exposed metal ends are clean and free of frayed strands.

Align the wires: Hold the stripped ends of both wires together, making sure they are neatly aligned with no stray strands crossing over.

Twist the wire nut: Firmly twist the wire nut clockwise onto the wires until it is tight and secure.

Insert the wires into the wire nut: Push the aligned wire ends all the way into the wire nut, ensuring that the bare metal is fully covered.

Test the connection: Gently tug on each wire to ensure they are firmly held in place and will not come loose.

Inspect the connection: Ensure that no exposed wires or loose strands are visible. If the connection is not secure, remove the wire nut and repeat the process.

⚠ Note: Always follow local electrical codes and regulations when performing electrical work. If unsure or uncomfortable with electrical tasks, consult a qualified electrician. Safety should always be a top priority.

FIXTURE ASSEMBLY & INSTALLATION

Step 5: Bulb Installation

- Remove the top part from the fixture.
- Insert the appropriate bulb ensuring it is seated securely in the socket.
- Reattach the top part to the fixture, making sure it is properly aligned and fastened.

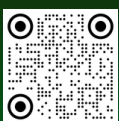

YOUTUBE VIDEO
INSTALLATION GUIDE



WEBSITE



CATALOG



(800) 360-2960



ABBALightingUSA@gmail.com



7701 Alabama Ave, Canoga Park, CA 91304

INSTALLATION GUIDE FOR SPB11

Step 6: Mounting the Fixture

- Insert the spike mount into the ground, ensuring it is vertical and stable for proper positioning.
- Adjust the light angle as needed to achieve the desired illumination.

Step 7: Power On & Final Adjustments

- Turn on the power to test the fixture.
- Make any final angle adjustments to ensure optimal lighting coverage.
- Verify proper operation before completing the installation.
- Bury the main cable underground for safety and protection from external elements.
- Do not exceed the maximum wattage specified for the fixture to prevent overheating or damage.
- Regularly inspect and maintain your lighting system to ensure long-term reliability.



YOUTUBE VIDEO
INSTALLATION GUIDE



WEBSITE

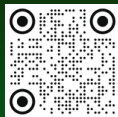

CATALOG



(800) 360-2960



ABBALightingUSA@gmail.com



7701 Alabama Ave, Canoga Park, CA 91304

INSTALLATION GUIDE FOR SPB11

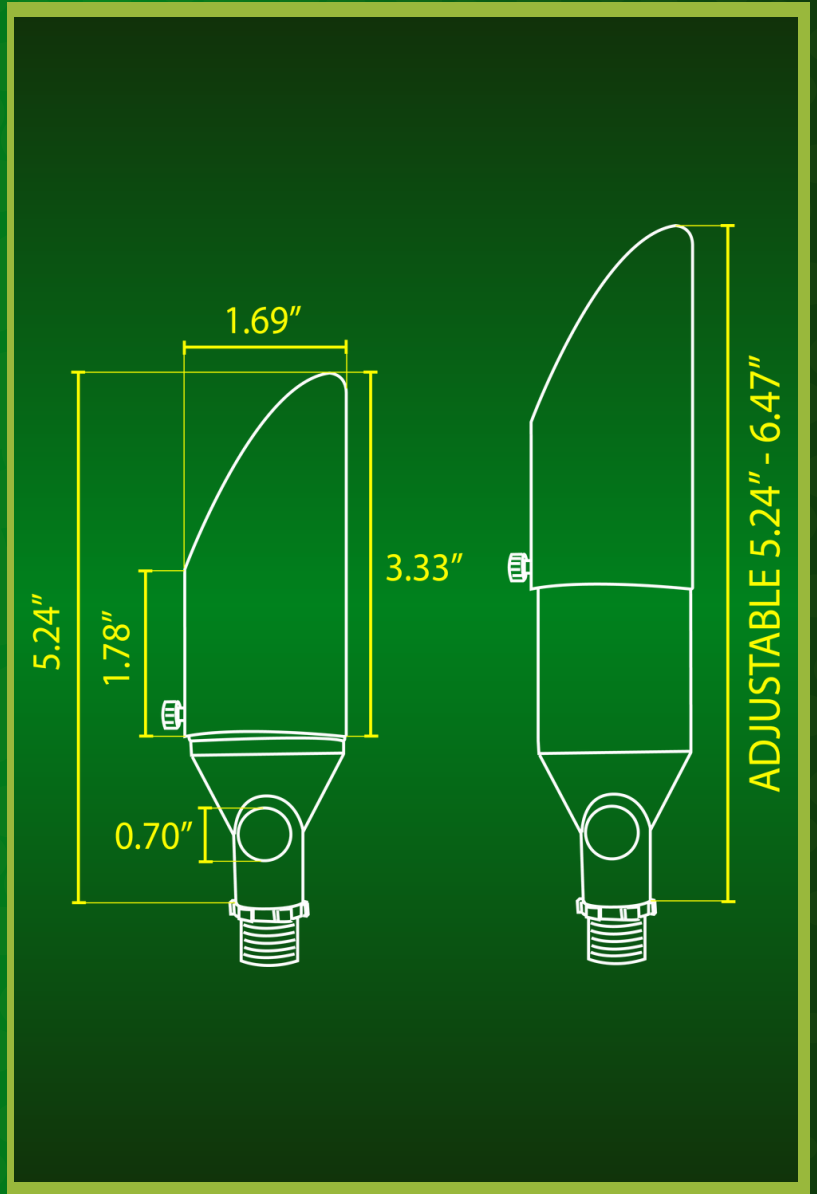

YOUTUBE VIDEO
INSTALLATION GUIDE



WEBSITE



CATALOG



(800) 360-2960



ABBALightingUSA@gmail.com



7701 Alabama Ave, Canoga Park, CA 91304

INSTALLATION GUIDE FOR SPB11

MAINTENANCE TIPS

- **Regular Inspection:** Periodically check the bracket and fixture to ensure they are still securely mounted and functioning correctly.
- **Surface Maintenance:** Monitor the mounting surface, particularly trees, to ensure the bracket does not cause damage as the tree grows.

SAFETY PRECAUTIONS

- Always wear appropriate safety gear, such as gloves and safety glasses, during installation.
- Ensure the mounting surface is capable of supporting the weight of both the bracket and the lighting fixture.

ADDITIONAL RESOURCES

For a detailed video tutorial on how to install, visit our YouTube channel and search for "SPB11"

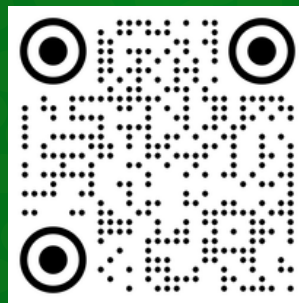

Please visit our website for more of our products.

www.ABBALightingUSA.com



YOUTUBE VIDEO
INSTALLATION GUIDE



WEBSITE

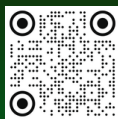

CATALOG



(800) 360-2960



ABBALightingUSA@gmail.com



7701 Alabama Ave, Canoga Park, CA 91304

SPBTII

SPOT LIGHT



2700K



3000K



4000K



5000K

