

# SPB03

SPOT LIGHT

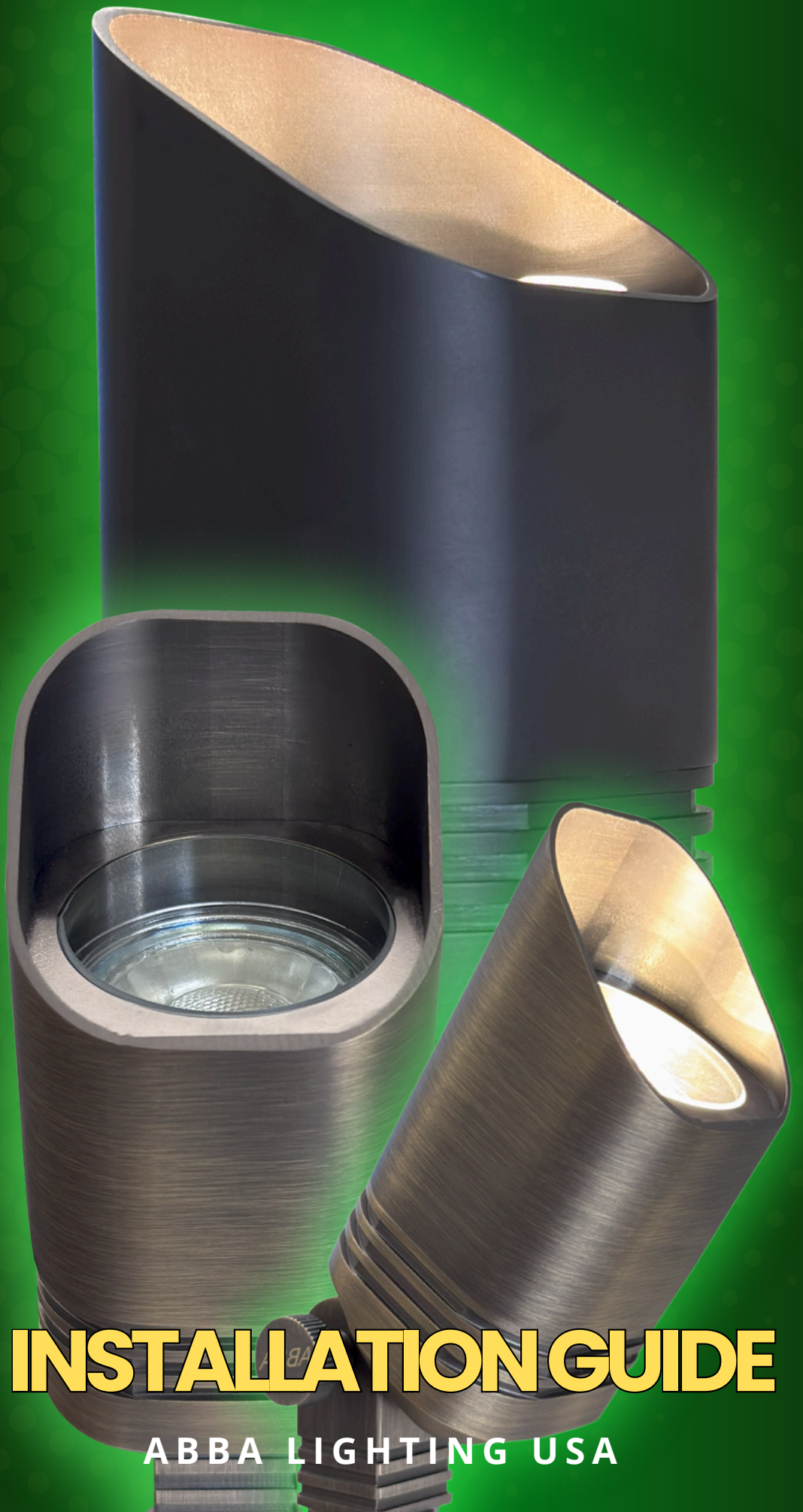

## INSTALLATION GUIDE

ABBA LIGHTING USA

# SPB03

SPOT LIGHT

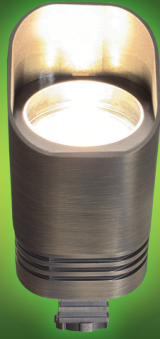

**HEAVY DUTY  
CAST  
BRASS**

## FINISH



**BULB:  
MR16**

# SPOTS

SPOT LIGHT



Thank you for choosing our high-quality product. To ensure the best possible experience, please take a moment to carefully read and follow all instructions before assembly, installation, and use. Doing so will not only guarantee proper function and safety but also help you maximize the full potential of this exceptional product. We truly appreciate your business and are honored to be your trusted provider of top-notch products!



YOUTUBE VIDEO  
INSTALLATION GUIDE



WEBSITE



CATALOG



(800) 360-2960



ABBALightingUSA@gmail.com



7701 Alabama Ave, Canoga Park, CA 91304

# WARNING

## TO REDUCE THE RISK OF FIRE OR INJURY TO PERSONS:

- ✓ Please exercise caution when using the lamp, as it tends to HEAT up rapidly. We recommend taking necessary safety measures to ensure optimal usage.
- ✓ For your safety, please refrain from touching the HOT lens, guard, or enclosure. We recommend waiting for the product to cool down before handling it.
- ✓ To prevent any fire hazards, please ensure that the lamp is kept away from materials that may easily catch fire. We appreciate your cooperation in maintaining a safe and secure environment.
- ✓ For safety reasons, we recommend that only a qualified professional install this electrical product.
- ✓ Before attempting to install this unit, ensure all power connections are off for your own safety.

# WARRANTY

- We stand behind the quality of our product and offer a 3 Year warranty. Kindly ensure that you keep the proof of purchase as it will be required for any warranty claims.
- Warranty will be void if there is any damage due to improper usage or modification to the fixture.
- Failure to comply with the instruction in this manual may increase the risk of damage or injury and will void warranty.



YOUTUBE VIDEO  
INSTALLATION GUIDE



WEBSITE



CATALOG



(800) 360-2960



ABBALightingUSA@gmail.com



7701 Alabama Ave, Canoga Park, CA 91304

# CAUTION:

**FIXTURE(S) MUST BE INSTALLED IN ACCORDANCE WITH ALL LOCAL CODES AND ORDINANCES.**

**DO NOT INSTALL WITHIN 10 FEET OF A POOL, SPA OR FOUNTAIN**

## PRODUCT OVERVIEW

Transform your outdoor spaces with the SPB03 Heavy-Duty Cast Brass Spotlight, a premium lighting solution designed to enhance the beauty of your landscape while withstanding the test of time. Crafted from high-quality cast brass, this spotlight offers unparalleled durability and a timeless aesthetic that complements any outdoor setting.

## PREMIUM BRASS CONSTRUCTION

Built from solid cast brass, the SPB03 spotlight is engineered to resist corrosion and harsh weather conditions, ensuring long-lasting performance and minimal maintenance. Its sturdy construction makes it ideal for both residential and commercial outdoor applications.

## ELEGANT FINISHES

Available in Natural Brass and Dark Brass finishes, this spotlight adds a touch of sophistication to your outdoor décor. The natural aging of brass over time develops a beautiful patina, further enhancing the visual appeal of your landscape.

## VERSATILE LIGHTING SOLUTIONS

Designed to accommodate MR16 LED 12V bulbs (sold separately), the SPB03 provides focused, adjustable illumination perfect for highlighting trees, shrubs, architectural features, and pathways. Its adjustable head allows you to direct light precisely where you need it, creating dramatic lighting effects and enhancing security.

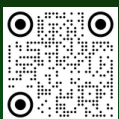

YOUTUBE VIDEO  
INSTALLATION GUIDE



WEBSITE



CATALOG



(800) 360-2960



ABBALightingUSA@gmail.com



7701 Alabama Ave, Canoga Park, CA 91304

# CAUTION:

**FIXTURE(S) MUST BE INSTALLED IN ACCORDANCE WITH ALL LOCAL CODES AND ORDINANCES.**

**DO NOT INSTALL WITHIN 10 FEET OF A POOL, SPA OR FOUNTAIN**

## EASY INSTALLATION WITH ABS GROUND SPIKE

The included ABS ground spike simplifies installation, allowing you to securely position the spotlight in soil or mulch. The spike ensures stability and easy relocation if your lighting needs change.

## WEATHERPROOF AND RELIABLE

With an IP65 waterproof rating, the SPB03 is built to withstand rain, snow, and dust, ensuring reliable operation in all weather conditions. The robust design protects internal components, providing peace of mind and consistent performance year-round.



YOUTUBE VIDEO  
INSTALLATION GUIDE



WEBSITE



CATALOG



(800) 360-2960



ABBALightingUSA@gmail.com



7701 Alabama Ave, Canoga Park, CA 91304

# CAUTION:

**FIXTURE(S) MUST BE INSTALLED IN ACCORDANCE WITH ALL LOCAL CODES AND ORDINANCES.**

**DO NOT INSTALL WITHIN 10 FEET OF A POOL, SPA OR FOUNTAIN**

Specification	Detail
<b>Model</b>	SPB03
<b>Material</b>	Solid Cast Brass
<b>Finish Options</b>	Natural Brass / Dark Brass
<b>Lamp Type</b>	MR16 LED, 12V (sold separately)
<b>Voltage</b>	12V Low Voltage
<b>Adjustability</b>	Tilt / pivoting head for directional control
<b>Environment Rating</b>	Outdoor – water/dust resistant
<b>Mounting Method</b>	Ground spike (included) or optional surface mounts
<b>Typical Dimensions</b>	2.25" (W) x 4.44" (H)

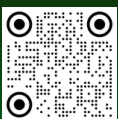

YOUTUBE VIDEO  
INSTALLATION GUIDE



WEBSITE



CATALOG



(800) 360-2960



ABBALightingUSA@gmail.com



7701 Alabama Ave, Canoga Park, CA 91304

# CAUTION:

**FIXTURE(S) MUST BE INSTALLED IN ACCORDANCE WITH ALL LOCAL CODES AND ORDINANCES.**

**DO NOT INSTALL WITHIN 10 FEET OF A POOL, SPA OR FOUNTAIN**

## IDEAL APPLICATIONS

- Tree Uplighting – Bring out the grandeur of tall trees by casting light upward into the canopy.
- Architectural Accents – Highlight textured walls, pillars, entryways, and building facades.
- Garden Feature Lighting – Showcase sculptures, fountains, or flower beds with tailored beams.
- Path & Walkway Enhancement – Provide subtle yet effective illumination for safe passage.
- Signage Illumination – Draw attention to business or property signs for visibility day and night.

## IMPORTANT SAFETY INFORMATION

To ensure optimal performance and safety, always use our fixtures ONLY with a low-voltage landscape transformer. This transformer reduces the voltage from 120V to 12V, making it safe and suitable for outdoor use. Failure to follow these guidelines may result in electrical hazards or damage to the fixture.



YOUTUBE VIDEO  
INSTALLATION GUIDE



WEBSITE



CATALOG



(800) 360-2960



ABBALightingUSA@gmail.com



7701 Alabama Ave, Canoga Park, CA 91304

# INSTALLATION GUIDE FOR SPB03

## STEP-BY-STEP INSTALLATION INSTRUCTIONS

### Step 1: Plan Your Layout

- **Determine Placement:** Choose the path or area where the lights will be installed. Measure the distance between lights to ensure even illumination. A typical spacing is 6–10 feet apart, depending on the desired light spread.
- **Consider Power Source:** Ensure that the Spotlight can be connected to a suitable power source. Ensure that the input voltage of the light cable wires is 12V AC/DC. Using improper voltage may cause malfunction or permanent damage to the fixture.

### Step 2: Prepare the Ground

- **Dig the Hole:** Using a shovel or trowel, dig a hole where you want to install the Spotlight. The hole should be deep enough to accommodate the ground stake.
- **Ensure Stability:** Make sure the hole is wide enough to allow the ground stake to sit firmly. Test-fit the stake by inserting it into the hole to ensure stability before proceeding.

### Step 3: Establish a Secure Electrical Connection

**For a dependable and long-lasting electrical connection between the fixture wires and the main line in outdoor or underground installations, follow these guidelines:**

- Use a direct burial-rated main cable connector designed to withstand environmental conditions, resist moisture and corrosion, and provide robust insulation.
- We recommend using WN12 waterproof wire nuts (sold separately) for optimal connectivity and protection against the elements.



YOUTUBE VIDEO  
INSTALLATION GUIDE



WEBSITE

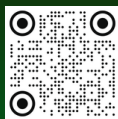

CATALOG



(800) 360-2960



ABBALightingUSA@gmail.com



7701 Alabama Ave, Canoga Park, CA 91304

# INSTALLATION GUIDE FOR SPB03

## Step 4: Wire Connection Instructions

**Strip the insulation:** Carefully strip approximately  $\frac{3}{4}$  inch (1.9 cm) of insulation from the ends of the two wires to be connected. Ensure that the exposed metal ends are clean and free of frayed strands.

**Align the wires:** Hold the stripped ends of both wires together, making sure they are neatly aligned with no stray strands crossing over.

**Twist the wire nut:** Firmly twist the wire nut clockwise onto the wires until it is tight and secure.

Insert the wires into the wire nut: Push the aligned wire ends all the way into the wire nut, ensuring that the bare metal is fully covered.

**Test the connection:** Gently tug on each wire to ensure they are firmly held in place and will not come loose.

**Inspect the connection:** Ensure that no exposed wires or loose strands are visible. If the connection is not secure, remove the wire nut and repeat the process.

**⚠ Note:** Always follow local electrical codes and regulations when performing electrical work. If unsure or uncomfortable with electrical tasks, consult a qualified electrician. Safety should always be a top priority.

## FIXTURE ASSEMBLY & INSTALLATION

### Step 5: Bulb Installation

- Remove the top part from the fixture.
- Insert the appropriate bulb ensuring it is seated securely in the socket.
- Reattach the top part to the fixture, making sure it is properly aligned and fastened.



YOUTUBE VIDEO  
INSTALLATION GUIDE



WEBSITE



CATALOG



(800) 360-2960



ABBALightingUSA@gmail.com



7701 Alabama Ave, Canoga Park, CA 91304

# INSTALLATION GUIDE FOR SPB03

## Step 6: Mounting the Fixture

- Insert the spike mount into the ground, ensuring it is vertical and stable for proper positioning.
- Adjust the light angle as needed to achieve the desired illumination.

## Step 7: Power On & Final Adjustments

- Turn on the power to test the fixture.
- Make any final angle adjustments to ensure optimal lighting coverage.
- Verify proper operation before completing the installation.
- Bury the main cable underground for safety and protection from external elements.
- Do not exceed the maximum wattage specified for the fixture to prevent overheating or damage.
- Regularly inspect and maintain your lighting system to ensure long-term reliability.

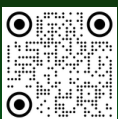

YOUTUBE VIDEO  
INSTALLATION GUIDE



WEBSITE

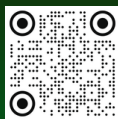

CATALOG



(800) 360-2960



ABBALightingUSA@gmail.com



7701 Alabama Ave, Canoga Park, CA 91304

# INSTALLATION GUIDE FOR SPB03

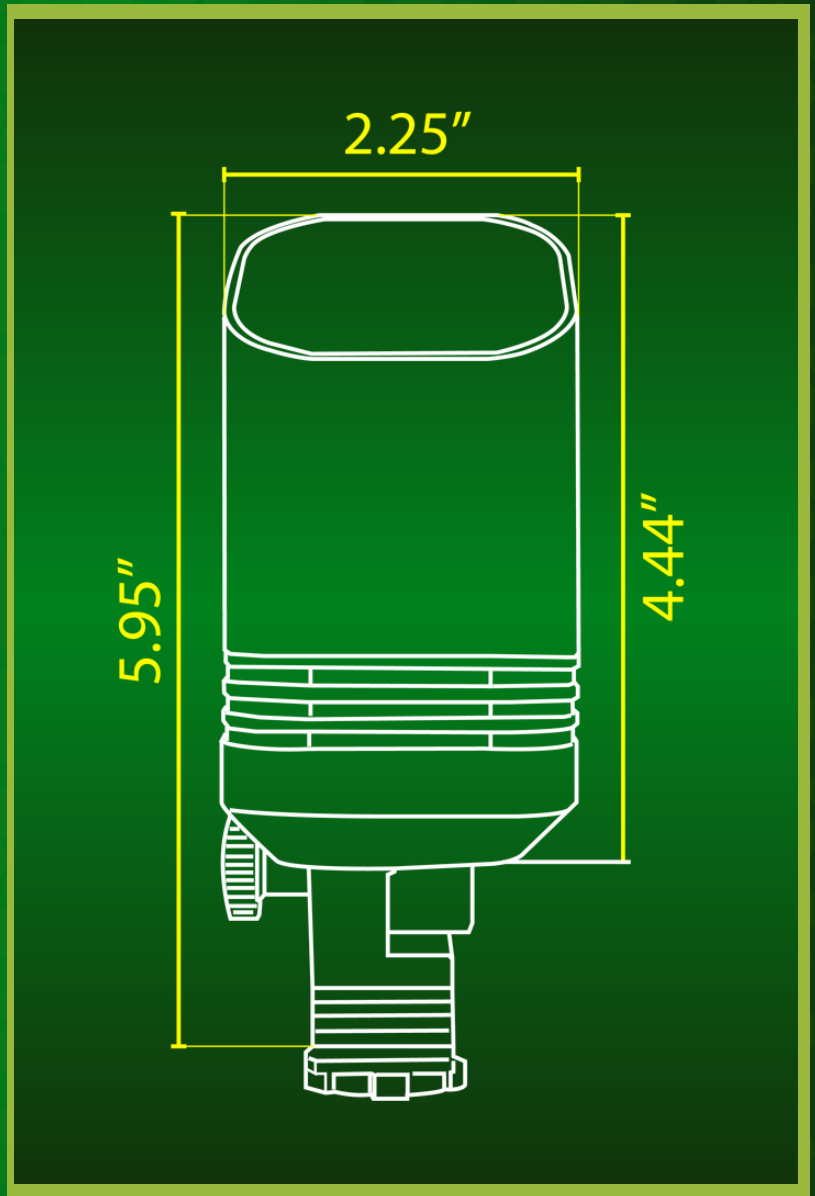

YOUTUBE VIDEO  
INSTALLATION GUIDE



WEBSITE



CATALOG



(800) 360-2960



ABBALightingUSA@gmail.com



7701 Alabama Ave, Canoga Park, CA 91304

# INSTALLATION GUIDE FOR SPB03

## MAINTENANCE TIPS

- **Regular Inspection:** Periodically check the bracket and fixture to ensure they are still securely mounted and functioning correctly.
- **Surface Maintenance:** Monitor the mounting surface, particularly trees, to ensure the bracket does not cause damage as the tree grows.

## SAFETY PRECAUTIONS

- Always wear appropriate safety gear, such as gloves and safety glasses, during installation.
- Ensure the mounting surface is capable of supporting the weight of both the bracket and the lighting fixture.

## ADDITIONAL RESOURCES

For a detailed video tutorial on how to install, visit our YouTube channel and search for "SPB03"

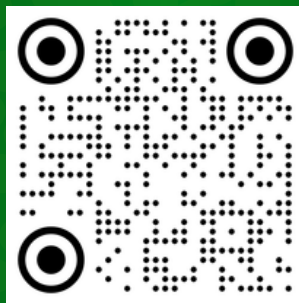

Please visit our website for more of our products.

[www.ABBALightingUSA.com](http://www.ABBALightingUSA.com)



YOUTUBE VIDEO  
INSTALLATION GUIDE



WEBSITE



CATALOG



(800) 360-2960



ABBALightingUSA@gmail.com



7701 Alabama Ave, Canoga Park, CA 91304

# SPB03

SPOT LIGHT



ABBA LIGHTING USA