

STABILIS

STEP LIGHT



INSTALLATION GUIDE

ABBA LIGHTING USA

STAIRS STEP LIGHT

CERTIFICATE:



MATERIAL:

**HEAVY DUTY
CAST
BRASS**

**WATERPROOF
RATING:**



**G4 BULB
(SOLD SEPARATELY)**



2700K

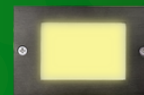

3000K

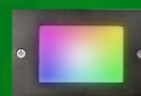

RGBCW



4000K

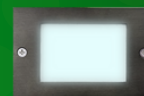

5000K

ABBA LIGHTING USA

Thank you for choosing our high-quality product. To ensure the best possible experience, please take a moment to carefully read and follow all instructions before assembly, installation, and use. Doing so will not only guarantee proper function and safety but also help you maximize the full potential of this exceptional product. We truly appreciate your business and are honored to be your trusted provider of top-notch products!

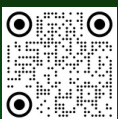

YOUTUBE VIDEO
INSTALLATION GUIDE



WEBSITE

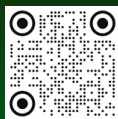

CATALOG



(800) 360-2960



ABBALightingUSA@gmail.com



7701 Alabama Ave, Canoga Park, CA 91304

WARNING

TO REDUCE THE RISK OF FIRE OR INJURY TO PERSONS:

- ✓ Please exercise caution when using the lamp, as it tends to HEAT up rapidly. We recommend taking necessary safety measures to ensure optimal usage.
- ✓ For your safety, please refrain from touching the HOT lens, guard, or enclosure. We recommend waiting for the product to cool down before handling it.
- ✓ To prevent any fire hazards, please ensure that the lamp is kept away from materials that may easily catch fire. We appreciate your cooperation in maintaining a safe and secure environment.
- ✓ For safety reasons, we recommend that only a qualified professional install this electrical product.
- ✓ Before attempting to install this unit, ensure all power connections are off for your own safety.

WARRANTY

- We stand behind the quality of our product and offer a 2 year warranty. Kindly ensure that you keep the proof of purchase as it will be required for any warranty claims.
- Warranty will be void if there is any damage due to improper usage or modification to the fixture.
- Failure to comply with the instruction in this manual may increase the risk of damage or injury and will void warranty.



YOUTUBE VIDEO
INSTALLATION GUIDE



WEBSITE



CATALOG



(800) 360-2960



ABBALightingUSA@gmail.com



7701 Alabama Ave, Canoga Park, CA 91304

CAUTION:

FIXTURE(S) MUST BE INSTALLED IN ACCORDANCE WITH ALL LOCAL CODES AND ORDINANCES.

DO NOT INSTALL WITHIN 10 FEET OF A POOL, SPA OR FOUNTAIN

STB15 Brass Step Light – Refined Illumination with Classic Brass Quality

The STB15 Brass Step Light from Abba Lighting USA is a refined outdoor lighting fixture designed to blend elegant material quality with practical functionality. Crafted from solid brass, this step light adds a touch of architectural sophistication to steps, deck edges, patios, walkways, and other low-level exterior surfaces while delivering dependable, versatile illumination.

This fixture is designed to operate with a G4 base bulb (sold separately), allowing you to choose the lumen output and color temperature that best suits your lighting goals. The compact, flush-mount form installs nearly level with the surface, creating a clean, unobtrusive look that enhances visibility and safety after dark without compromising your landscape's aesthetic.

Whether accenting a pathway, highlighting transitions between outdoor areas, or adding ambient glow to a seating terrace, the STB15 offers a flexible lighting solution with timeless brass styling.

G4 Bulb Compatible

Designed to accept a G4 base light bulb (sold separately), giving you flexibility to tailor brightness and color tone.

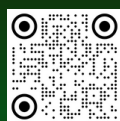

YOUTUBE VIDEO
INSTALLATION GUIDE



WEBSITE



CATALOG



(800) 360-2960



ABBALightingUSA@gmail.com



7701 Alabama Ave, Canoga Park, CA 91304

CAUTION:

FIXTURE(S) MUST BE INSTALLED IN ACCORDANCE WITH ALL LOCAL CODES AND ORDINANCES.

DO NOT INSTALL WITHIN 10 FEET OF A POOL, SPA OR FOUNTAIN

Solid Brass Housing

Durable brass construction resists corrosion and ages gracefully in outdoor environments.

12V Low-Voltage Operation

Compatible with common low-voltage landscape lighting systems for efficient and safe performance.

Weather-Ready Design

Built to withstand moisture, temperature variations, and exterior conditions for reliable seasonal use.

Flush Recessed Mount

Integrates neatly into steps, decking, or hardscape surfaces with a low-profile presence that complements architectural styles.

Versatile Accent Lighting

Ideal for stair risers, patios, deck edges, walkways, and other areas requiring subtle yet effective lighting.



YOUTUBE VIDEO
INSTALLATION GUIDE



WEBSITE



CATALOG



(800) 360-2960



ABBALightingUSA@gmail.com



7701 Alabama Ave, Canoga Park, CA 91304

CAUTION:

FIXTURE(S) MUST BE INSTALLED IN ACCORDANCE WITH ALL LOCAL CODES AND ORDINANCES.

DO NOT INSTALL WITHIN 10 FEET OF A POOL, SPA OR FOUNTAIN

Specification	Details
Model	STB15
Material	Solid Brass
Bulb Type	G4 Base (sold separately)
Operating Voltage	12V Low Voltage
Mounting Type	Flush recessed installation
Weather Rating	IP65 Outdoor-rated
Recommended Use	Decks, patios, walkways



YOUTUBE VIDEO
INSTALLATION GUIDE



WEBSITE



CATALOG



(800) 360-2960



ABBALightingUSA@gmail.com



7701 Alabama Ave, Canoga Park, CA 91304

CAUTION:

FIXTURE(S) MUST BE INSTALLED IN ACCORDANCE WITH ALL LOCAL CODES AND ORDINANCES.

DO NOT INSTALL WITHIN 10 FEET OF A POOL, SPA OR FOUNTAIN

Ideal Applications

- Step riser and stair lighting
- Deck and patio perimeter illumination
- Walkway accent lighting
- Garden edge and landscape transitions
- Outdoor feature lighting in residential or commercial settings

Why Choose the STB15 Brass Step Light?

The STB15 Brass Step Light provides a winning combination of timeless material, customizable lighting, and dependable outdoor performance. With its solid brass build and G4 bulb compatibility, this fixture offers both aesthetic flexibility and functional lighting that enhances safety and ambiance in exterior environments. Whether used in residential landscapes or commercial grounds, it brings elegant, adaptable illumination to any outdoor space.

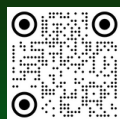

YOUTUBE VIDEO
INSTALLATION GUIDE



WEBSITE



CATALOG



(800) 360-2960



ABBALightingUSA@gmail.com



7701 Alabama Ave, Canoga Park, CA 91304

CAUTION:

INSTALLATION GUIDE FOR STB15

STEP-BY-STEP INSTALLATION INSTRUCTIONS

To ensure optimal performance and maximum safety, use this fixture **ONLY** with a low-voltage landscape transformer.

The transformer reduces standard household voltage from 120V to 12V, making it safe and suitable for outdoor applications.

1. Open the Fixture

- Loosen and remove the screws.
- Carefully open the fixture to access the interior components.
- Carefully insert a compatible G4 bulb into the socket. This fixture does not include a bulb; G4 lamp is sold separately.

2. Position the Mounting Plate

- Hold the mounting plate against the wall at the desired height and orientation.
- Use a level to ensure the plate is properly aligned (horizontal or vertical as desired).

3. Mark the Drill Points

- With a pencil or marker, mark the screw hole locations through the holes in the mounting plate.

4. Drill Pilot Holes

- Select a drill bit slightly smaller than the mounting screws.
- Drill pilot holes at each marked location.
- Do not drill deeper than the length of the screws.

Concrete Installation:

If installing into concrete or stairs, create conduit raceways inside the formwork using 1-inch dowels and PVC pipe before pouring concrete.

After the concrete cures, remove the dowels and finish the surface of each riser as required.

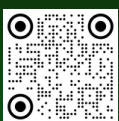

YOUTUBE VIDEO
INSTALLATION GUIDE



WEBSITE



CATALOG



(800) 360-2960



ABBALightingUSA@gmail.com



7701 Alabama Ave, Canoga Park, CA 91304

CAUTION:

INSTALLATION GUIDE FOR STB15

STEP-BY-STEP INSTALLATION INSTRUCTIONS

5. Prepare the Electrical Connections

We recommend using WN12 Waterproof Wire Nuts (sold separately) for optimal performance and protection.

a. Strip the Wires

- Strip approximately $\frac{3}{4}$ inch (1.9 cm) of insulation from each wire end.
- Ensure the exposed conductors are clean and free of frayed strands.

b. Align the Wires

- Hold the stripped ends together neatly, with no stray strands crossing.

c. Install the Wire Nut

- Insert the aligned wires fully into the wire nut.
- Twist the wire nut clockwise until snug and secure.
- For additional protection, wrap the connection with electrical tape.

d. Test the Connection

- Gently tug each wire to verify a secure connection.

6. Mount the Fixture

- Align the metal mounting plate with the pilot holes.
- Insert the screws through the mounting plate.
- Tighten evenly using a screwdriver.
- Do not overtighten.
- Confirm the plate is firm, level, and free from wobble.

Deck Installation:

Carefully position the mounting plate within the deck opening before securing.

7. Final Assembly

- Place the top cover of the fixture in position.
- Secure it by tightening the side screws firmly.

8. Power & Testing

- Restore power at the transformer or breaker.
- Turn the system on and verify proper operation.
- Adjust the fixture orientation as desired and re-test.



YOUTUBE VIDEO
INSTALLATION GUIDE



WEBSITE

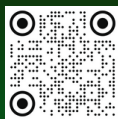

CATALOG



(800) 360-2960



ABBALightingUSA@gmail.com



7701 Alabama Ave, Canoga Park, CA 91304

INSTALLATION GUIDE FOR STB15

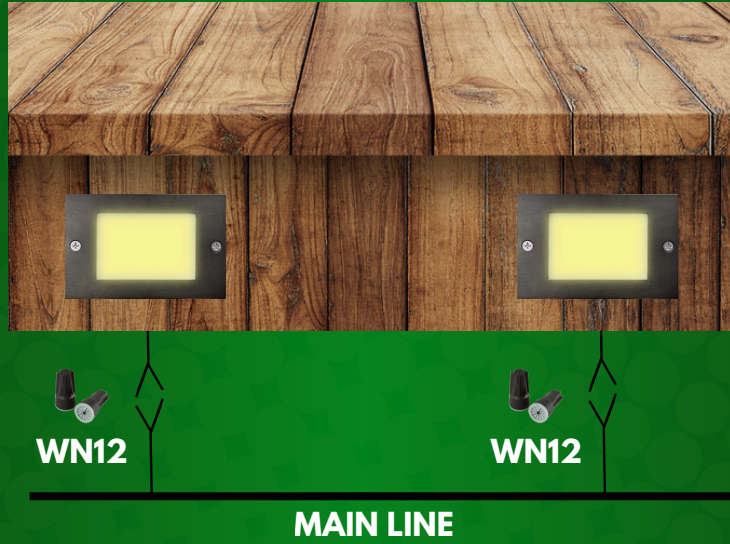

WN12

WN12

MAIN LINE

Attach the wires from the fixture(s) to the main cable, For best results, we recommend using WN12 waterproof wire nuts (which are sold separately)

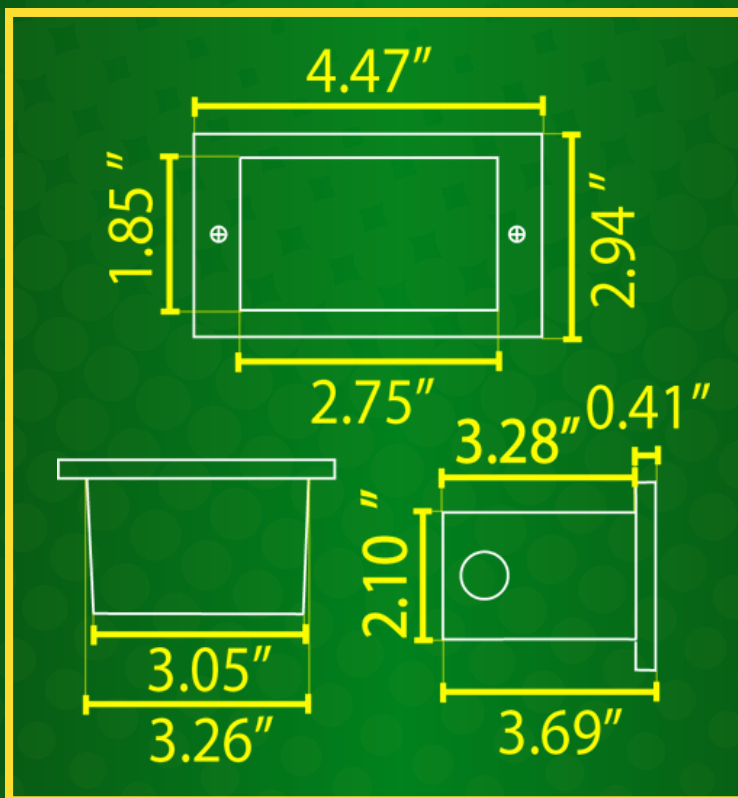

YOUTUBE VIDEO
INSTALLATION GUIDE



WEBSITE



CATALOG



(800) 360-2960



ABBALightingUSA@gmail.com



7701 Alabama Ave, Canoga Park, CA 91304

INSTALLATION GUIDE FOR STB15

MAINTENANCE TIPS

- **Regular Inspection:** Periodically check the bracket and fixture to ensure they are still securely mounted and functioning correctly.

SAFETY PRECAUTIONS

- Always wear appropriate safety gear, such as gloves and safety glasses, during installation.
- Ensure the mounting surface is capable of supporting the weight of both the bracket and the lighting fixture.

ADDITIONAL RESOURCES

For a detailed video tutorial on how to install, visit our YouTube channel and search for "STB15"

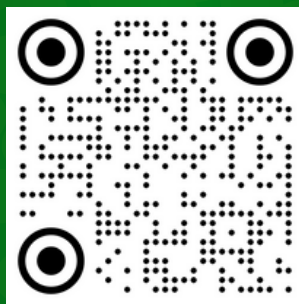

Please visit our website for more of our products.

www.ABBALightingUSA.com

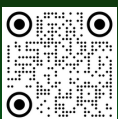

YOUTUBE VIDEO
INSTALLATION GUIDE



WEBSITE



CATALOG



(800) 360-2960



ABBALightingUSA@gmail.com



7701 Alabama Ave, Canoga Park, CA 91304

STB15

STEP LIGHT



2700K



3000K



RGBCW



4000K



5000K