

ABBA

LIGHTING USA

12V Landscape Light Specialist











STS600 INSTALLATION GUIDE

www.ABBALightingUSA.com

RATED VOLTAGE 12V

Congratulations on your purchase of this high-quality product! We want to ensure that you have the best possible experience with it, so we kindly ask that you take a moment to carefully read and follow all instructions before assembly, installation, and use. By doing so, you'll not only guarantee correct function and safety, but also optimize the full potential of this exceptional product. Thank you for choosing us as your trusted provider of top-notch products - we truly appreciate your business!

WARNING: TO REDUCE THE RISK OF FIRE OR INJURY TO PERSONS:

-  For safety reasons, we recommend that only a qualified professional install this electrical product.
-  Before attempting to install this unit, ensure all power connections are off for your own safety.
-  Fixture(s) must be installed in accordance with all local codes and ordinances.
-  Do not instal within 10 feet of a pool, spa or fountain
-  **DO NOT DISASSEMBLE**
-  To ensure proper functionality and safety, it is important to refrain from connecting two or more transformers in parallel. It is advised to maintain individual electrical circuits for each transformer rather than attempting to combine their outputs. By adhering to this guideline, you can prevent potential complications and optimize the performance of each transformer.
-  For optimal performance and safety, it is recommended not to utilize this device in conjunction with a dimmer switch. Avoid connecting the device to any dimming mechanism as it may lead to undesirable consequences or malfunctioning. It is advisable to operate the device without the use of a dimmer to ensure its intended functionality and prevent any potential risks.
-  To ensure the highest level of safety, it is recommended to directly plug the transformer into a Ground Fault Circuit Interrupter (GFCI) outlet. By utilizing a GFCI outlet, you enhance protection against electrical shocks and minimize the risk of electrical hazards.

- ✔ To maintain optimal performance and safety, it is strongly advised against using an extension cord with this device. It is recommended to directly connect the device to a properly grounded power outlet. Using an extension cord may introduce electrical inefficiencies, increase the risk of overheating, or compromise the device's functionality. It is best to avoid extension cords and ensure a direct and secure power connection for the device.
- ✔ It is important to note that the maximum output capacity of this transformer is 600 Watts. To ensure safe and optimal operation, it is crucial to avoid exceeding this specified limit. Overloading the transformer by drawing power beyond its maximum capacity can lead to overheating, reduced efficiency, and potential damage to the device. It is highly advised to carefully monitor the power requirements of your equipment and ensure they fall within the specified limits of the transformer to maintain its performance and longevity.

WARRANTY

- We stand behind the quality of our product and offer a 2-year warranty from the date of purchase. Please note that the warranty is valid from the date of purchase, not from the date of installation. Kindly ensure that you keep the proof of purchase as it will be required for any warranty claims.
- Warranty will be void if there is any damage due to improper usage or modification to the fixture.
- Failure to comply with the instruction in this manual may increase the risk of damage or injury and will void warranty.

We assure you that this transformer is designed with utmost consideration for safety, making it suitable for both indoor and outdoor applications. You can confidently utilize this transformer in various environments without any concerns about compromising safety standards. Moreover, it is essential to note that this transformer is specifically engineered to be weatherproof, offering enhanced protection against the elements. This means that you can rely on its performance and durability even when exposed to challenging weather conditions. Whether you are working on a project indoors or venturing into outdoor settings, this transformer provides a secure and dependable solution for your electrical needs.

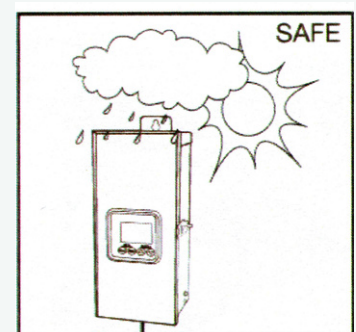

To ensure proper installation of the transformer, it is essential to position it at a level where the controls are readily visible and easily accessible. This ensures convenient operation and maintenance of the transformer. When selecting the installation location, carefully consider factors such as line of sight and ergonomic accessibility. By placing the transformer at an appropriate level, you will be able to monitor and adjust its settings with ease, facilitating efficient and effective usage. Prioritizing the visibility and accessibility of the controls when installing the transformer contributes to a user-friendly and ergonomic setup.

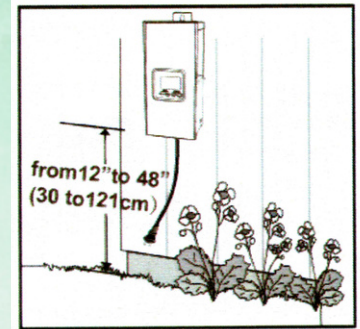

It is crucial to avoid installing the transformer in a position that obstructs or blocks the sensor responsible for the dusk-to-dawn mode. When choosing the installation location, be mindful of the sensor's line of sight and ensure that it remains unobstructed. Placing the transformer in a position that allows the sensor to function optimally ensures the proper operation of the dusk-to-dawn mode, which automatically adjusts the transformer's functionality based on ambient light levels. By preventing any obstructions to the sensor, you guarantee the reliable and accurate performance of this mode, enhancing the overall efficiency and effectiveness of the transformer's operation.

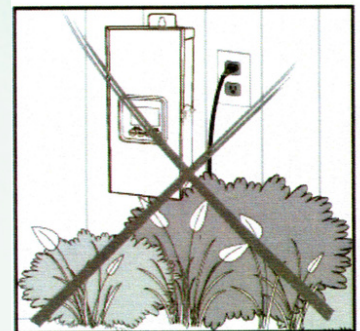

INSTALLATION INSTRUCTION

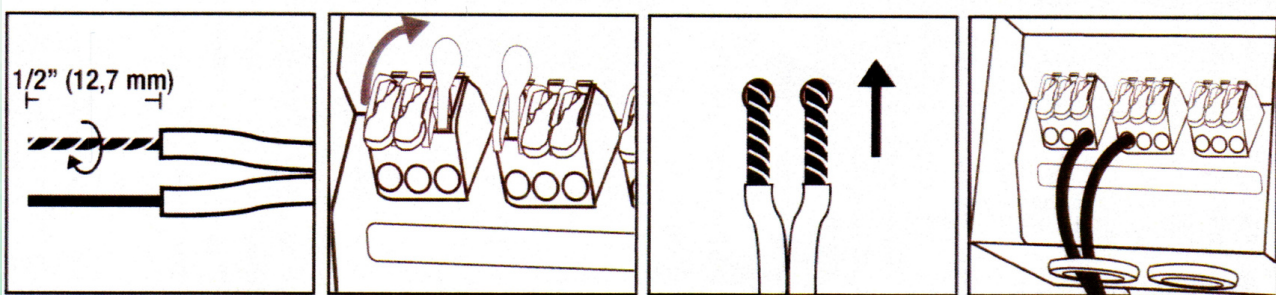

To prepare the landscape wire for connection, follow these simple steps:

- Strip 1/2 inch of insulation from both wires.
- Twist the exposed ends of the wires together tightly.

- On the terminal block, locate the lever, which is a small movable mechanism used to secure or release the electrical connections.

To connect the wires to the transformer, please carefully follow these step-by-step instructions:

- Locate the "COM" block terminal on the transformer. This terminal is designated for the common wire connection.
- Take the first wire and insert it into the "COM" block terminal. Ensure that the wire is fully inserted and securely positioned within the terminal.
- Identify the "15V" block terminal on the transformer. This terminal is intended for the connection of the other wire.
- Insert the second wire into the "15V" block terminal, ensuring a secure and complete insertion within the terminal.
- Once both wires are correctly positioned in their respective block terminals, locate the levers associated with each terminal block.
- Using gentle pressure, push the levers down to secure the wires in place. Confirm that the levers are fully engaged and that the wires are firmly held within the block terminals.

After connecting the wires to the terminal blocks, it is vital to verify that they are securely and properly positioned. Follow these steps to ensure a secure connection and complete the installation:

1. Carefully inspect the terminal blocks to confirm that the wires are fully inserted and tightly secured within their respective terminals. Make sure there are no loose or exposed wires.
2. Gently tug on each wire to ensure it is firmly held in place and does not come loose. This step helps verify the stability of the connections.
3. Once you have confirmed the secure placement of the wires, proceed to close the casing of the transformer. Align the casing properly with the unit.

4. Double-check that the casing is closed securely and there are no gaps or openings.

By following these instructions, you will guarantee that the wires are securely placed within the terminal blocks, minimizing the risk of disconnections or electrical issues. Additionally, closing the casing properly provides protection to the internal components of the transformer.

MOUNT THE INSTALLATION

To mount the transformer on a wall near an electrical outlet, carefully follow these step-by-step instructions:

- Choose a suitable location on the wall near the electrical outlet where you intend to install the transformer. Ensure that the chosen spot allows for easy access to the outlet and is appropriate for the weight and size of the transformer.
- Hold the transformer against the wall at the desired mounting height. Position it in a way that aligns with the electrical outlet and any necessary connections.
- With a pencil or marker, mark the spots on the wall where the screw holes of the transformer will align. These marks will serve as a guide for secure mounting.
- Obtain appropriate screws that are compatible with the wall material and the transformer's mounting holes. Generally, wall anchors may be necessary for mounting on drywall or other fragile surfaces. If unsure, consult a hardware store or professional for suitable mounting hardware.
- Using a suitable screwdriver or drill, carefully insert the screws through the mounting holes of the transformer and into the marked spots on the wall. Ensure that the screws are driven straight and fully into the wall, providing a secure hold.
- Once the screws are tightly secured, verify that the transformer is firmly mounted on the wall by giving it a gentle tug or shake. Ensure that it does not move or feel loose.

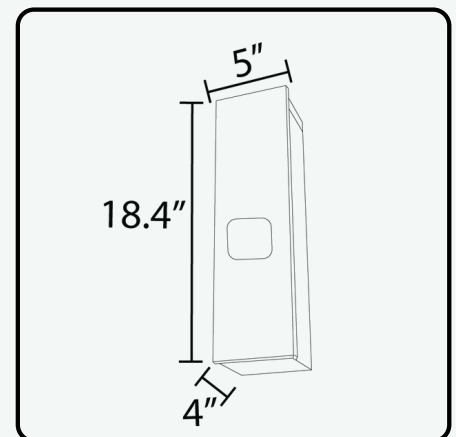
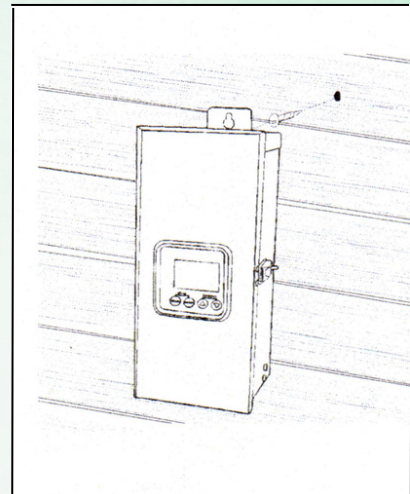

RUN THE LANDSCAPE WIRE (SOLD SEPARATELY)

To ensure proper installation of the landscape wire, please follow these guidelines:

- When running the landscape wire, make sure it extends directly from the transformer to each light without any cuts or interruptions. This uncut wire connection helps maintain a consistent and reliable electrical flow throughout the lighting system.
- Exercise caution and avoid running the wire within a proximity of 10 feet (3 meters) to any pools, spas, or fountains. This safety measure prevents any potential hazards associated with water and electrical components. It is important to prioritize the safety of individuals and the proper functioning of the electrical system.
- In the event that the landscape wire is longer than needed, you may need to trim it to the appropriate length. To cut the wire, use a cable cutter specifically designed for this purpose. Ensure that the cable cutter is suitable for the wire's gauge and thickness. Following the manufacturer's instructions, carefully cut the wire to the desired length.
- By adhering to these instructions, you will ensure the integrity and safety of the landscape wire installation. The wire should remain uncut as it runs from the transformer to each light, while maintaining a safe distance from pools, spas, or fountains. If necessary, use a cable cutter to trim the wire to the required length.

When selecting the cable gauge, consider the distance between the transformer and the lighting fixtures. It is crucial to choose an appropriate gauge to ensure efficient power transmission and minimize voltage drop.

Please note that this chart provides general recommendations, and it is essential to consider specific factors such as the power requirements of your lighting system and any local electrical codes or regulations that may apply. Consulting with a qualified electrician can provide further guidance and ensure the proper selection of cable gauges for your specific installation.

HOW TO CHOOSE THE RIGHT LOW VOLTAGE WIRE:

Feet	10	20	30	40	50	60	70	80	90	100	110	120	130	140	150	160	170	180	190	200	
Watts																					
40	16	16	16	16	16	16	16	14	14	12	12	12	12	12	12	12	12	12	10	10	
60	16	16	16	16	16	16	14	14	14	12	12	12	12	12	12	12	12	10	10	8	
80	16	16	16	16	14	14	14	14	14	12	12	12	12	10	10	10	10	10	10	8	8
100	16	16	14	14	14	14	14	12	12	12	12	10	10	10	10	10	10	10	8	8	8
120	12	12	12	12	12	12	12	12	12	12	10	10	10	10	10	10	8	8	8	8	8
140	12	12	12	12	12	12	12	10	10	10	10	10	10	8	8	8	8	8	8	8	8
160	12	12	12	12	12	12	10	10	10	10	8	8	8	8	8	8	8				
180	12	12	12	12	12	10	10	10	10	8	8	8	8	8	8	8					
200	12	12	12	12	12	10	10	10	8	8	8	8	8	8							
220	12	12	12	12	10	10	10	8	8	8	8	8									
240	12	12	12	10	10	10	8	8	8	8											
260	12	12	10	10	10	8	8	8	8												
280	12	10	10	10	8	8	8	8													
300	12	10	10	10	8	8	8	8													
320	12	10	10	10	8	8	8	8													
340	12	10	10	10	8	8	8	8													
360	12	10	10	10	8	8	8														

1. LOWER GAUGE WIRES ARE THICKER AND CONTAIN MORE COPPER. THEY HAVE A GREATER CURRENT CARRYING CAPACITY FOR LONG RUNS

2. ITS BEST TO NOT EXCEED MORE THAN 80% OF YOUR LANDSCAPE WIRE CURRENT CAPACITY TO ENSURE THERE IS NO VOLTAGE DROP

EXAMPLE: IF YOUR TOTAL WATTAGE OF YOUR LANDSCAPE LIGHTS IS 40 WATTS, THEN YOU CAN RUN 200 FEET OF 12 GAUGE WIRE WITHOUT VOLTAGE DROP.

POWER UP THE TRANSFORMER

To test the fixtures and change the mode to "ON," please follow these instructions:

- Take the plug of the transformer and insert it into the GFCI plug. Make sure it is fully inserted and securely connected.
- Once the transformer is plugged into the GFCI plug, you can proceed with testing the fixtures. Turn on the power to the transformer.
- Set the mode switch to the "ON" position. This will activate the fixtures and provide a continuous power supply.

Observe the connected fixtures to verify that they are illuminated and functioning correctly. Check for any signs of flickering, dimness, or malfunctions.



Please ensure that you do not exceed the capacity of the transformer as it can lead to overheating and overload, potentially reducing its lifespan. It is recommended to utilize only up to 85% of the transformer's capacity.

SETTING UP THE TRANSFORMER

This transformer offers two convenient methods for setting its operation: through a smartphone app or manually on the transformer itself. Here are the details for the manual setting options available:

On/Off/Auto (Photo Sensor) Mode: The transformer provides three options for this mode:

On: In this mode, the connected lights will remain continuously on, regardless of ambient light conditions.

Auto (Photo Sensor): This mode utilizes a built-in photo sensor on the transformer. The connected lights will automatically turn on at dusk and turn off at dawn, based on the detected ambient light levels. It offers a convenient dusk-to-dawn working mode, ensuring efficient and automated lighting control.

Timer Mode: The transformer also offers three timer options, allowing the lights to remain on for a specified duration after dusk. You can choose from 2, 4, 6, or 8-hour durations. Here's how it works:

Selecting the desired timer duration will trigger the lights to turn on at dusk and remain illuminated for the specified time period (e.g., 4, 6, or 8 hours).

After the set duration, the transformer will automatically turn off the lights, conserving energy and providing flexibility for customized lighting schedules.

By using the transformer's manual settings, you can easily configure the desired mode of operation for your lighting system. Whether you prefer continuous illumination, automated dusk-to-dawn functionality, or timed durations, this transformer offers versatile options to suit your needs.

Astronomic timer: The device offers an astronomical mode that aligns with your local sunrise and sunset times. It is specifically designed for indoor use in areas with inadequate natural lighting. Please ensure that you have selected your location from the provided city code sheet by referring to the "location" icon.

To set the astronomic auto ON and OFF mode, follow these steps:

1. Press the up and down buttons simultaneously to select the astro icon.
2. Press the enter button to confirm the selection. The astro icon and ".00" icon will start blinking.
3. Press the enter button once more to activate the half sunrise button, which will also shine.
4. Press the enter button to complete the astronomic auto ON and OFF mode setting. Please note that this mode is the default mode for the astronomic feature.

Optional settings

To configure the optional ON time setting, follow these instructions:

1. When you observe the astro icon and ".00" blinking, utilize the up and down buttons to adjust the start ON time.
2. You can set the start ON time to be 10-15 minutes advanced or delayed from the actual sunset time.
3. Press the enter button to confirm your selected ON time.

Optional Specific OFF time setting

To set a specific end OFF time, follow these steps:

1. When you notice the clock AM/PM icon and half sunrise icon blinking, it indicates that the device is ready for the end OFF time configuration.
2. Utilize the up and down buttons to select the desired specific time.
3. Press the enter button to confirm the selected end OFF time.
4. Always remember to press the enter button after selecting the desired hours and minutes.

The LCD display will show the loading consumption rate, and you will notice a blinking overload warning icon.

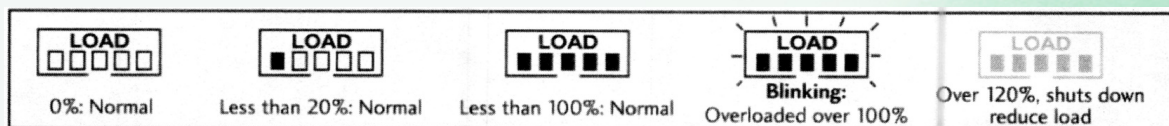

The device incorporates built-in protection against overloads and short circuits. To activate and reset this protection, simply press the MODE button.

- 2 x 300W independent mode setting zones;
- 2x COM/ 12V or 15V output x3 lines
- Toolless quick connectors/taps

United States:

- | | | |
|---|---------------------------|---|
| 01: Pennsylvania | 37: Michigan (North) | 74: Texas (North) |
| 02: Indiana (Eastern time zone) | 38: Michigan (South) | 75: Texas (South) |
| 03: Alaska (Central time zone) | 39: Minnesota (North) | 76: Texas (West) |
| 04: Arizona (no DST) | 40: Minnesota (South) | 77: Utah |
| 05: South Dakota
(Central time zone) | 41: Mississippi (North) | 78: Vermont |
| 06: Arkansas | 42: Mississippi (South) | 79: Virginia (East) |
| 07: California (Central) | 43: Missouri (North) | 80: Virginia (West) |
| 08: California (North) | 44: Missouri (South) | 81: Washington |
| 09: California (South) | 45: Montana (East) | 82: West Virginia |
| 10: Colorado (North) | 46: Montana (West) | 83: Wisconsin |
| 11: Colorado (South) | 47: Nebraska (East) | 84: Wyoming |
| 12: Connecticut | 48: Nebraska (West) | |
| 13: Delaware | 49: Nevada (North) | Canada: |
| 14: Florida (North) | 50: Nevada (South) | |
| 15: Florida (South) | 51: New Hampshire | 101: Charlottetown,
Prince Edward Island |
| 16: Florida (West) | 52: New Jersey | 102: Whitehorse, Yukon |
| 17: Georgia (North) | 53: New Mexico (North) | 103: Montréal, Quebec |
| 18: Georgia (South) | 54: New Mexico (South) | 104: Quebec |
| 19: Hawaii | 55: New York (South) | 105: Prince Edward Island |
| 20: Idaho (North) | 56: New York (Upstate) | 106: Ottawa, Ontario |
| 21: Idaho (South) | 57: North Carolina (East) | 107: Toronto |
| 22: Illinois (North) | 58: North Carolina (West) | 108: Barrie, Ontario |
| 23: Illinois (South) | 59: North Dakota (East) | 109: Iqaluit, Nunavut |
| 24: Indiana (Southern) | 60: North Dakota (West) | 110: North Sydney, Nova Scotia |
| 25: Iowa (East) | 61: Ohio | |
| 26: Iowa (West) | 62: Oklahoma | |
| 27: Kansas (East) | 63: Oregon (East) | |
| 28: Kansas (West) | 64: Oregon (West) | |
| 29: Kentucky (East) | 65: Pennsylvania (East) | |
| 30: Kentucky (West) | 66: Pennsylvania (West) | |
| 31: Louisiana (North) | 67: West Virginia | |
| 32: Louisiana (South) | 68: Rhode Island | |
| 33: Maine | 69: South Carolina | |
| 34: Maryland (East) | 70: South Dakota (West) | |
| 35: Maryland (West) | 71: Tennessee (West) | |
| 36: Massachusetts | 72: Tennessee (East) | |
| | 73: Texas (East) | |